



**ČERVENKA
CONSULTING**

Červenka Consulting s.r.o.

Na Hřebenkách 55

150 00 Prague

Czech Republic

Phone: +420 220 610 018

E-mail: cervenka@cervenka.cz

Web: <http://www.cervenka.cz/>

ATENA Program Documentation Part 11

Troubleshooting Manual

Written by

Dobromil Pryl and Jan Červenka

Prague, 23. 9. 2020



Trademarks:

ATENA is registered trademark of Vladimir Cervenka.

GiD is registered trademark of CIMNE of Barcelona, Spain.

Microsoft and Microsoft Windows are registered trademarks of Microsoft Corporation.

Other names may be trademarks of their respective owners.

Copyright © 2000-2020 Červenka Consulting s.r.o.

CONTENTS

1	INTRODUCTION.....	6
2	GENERAL QUESTIONS, MESSAGES, PROBLEMS, AND INSTRUCTIONS.....	7
2.1	General problems.....	7
2.1.1	<i>I have a problem not listed here.....</i>	<i>7</i>
2.1.2	<i>What is ATENA?.....</i>	<i>8</i>
2.1.3	<i>What is SBETA?.....</i>	<i>8</i>
2.1.4	<i>Can I analyze 3D structures with ATENA?.....</i>	<i>8</i>
2.1.5	<i>Are there any solved examples?.....</i>	<i>9</i>
2.1.6	<i>I plan to buy a new PC to run ATENA on it, what do you recommend?.....</i>	<i>9</i>
2.1.7	<i>Can I run ATENA on Linux? Can I install it on my Mac with OS X?.....</i>	<i>10</i>
2.1.8	<i>I understand the 'fixed crack model coefficient' switches between fixed and rotated cracks. Standard the value is 1, but what does that mean?.....</i>	<i>10</i>
2.1.9	<i>Does the non linear analysis of ATENA consider the geometrical nonlinearity (second order effects, like buckling or necking)?.....</i>	<i>11</i>
2.1.10	<i>The tensile (or compressive) stresses exceed the tensile (or compressive) strength or yield stress – what is wrong?.....</i>	<i>11</i>
2.1.11	<i>Unrealistic damage near loading/support plates during shrinkage or pre- or post-tensioning.....</i>	<i>13</i>
2.1.12	<i>Strange deformations in a corner or on an edge.....</i>	<i>13</i>
2.1.13	<i>A monitoring point shows no value, the program gives me an error on reading a monitor value.....</i>	<i>14</i>
2.1.14	<i>Problem with some graphics drivers.....</i>	<i>14</i>
2.1.15	<i>Sometimes, after lot of editing, an error message appears.....</i>	<i>15</i>
2.1.16	<i>Some materials do not support Tangent predictor.....</i>	<i>15</i>
2.1.17	<i>It is not possible to read results created with version 4.x.x or 1.2.3 and older of the program.....</i>	<i>15</i>
2.1.18	<i>Wrongly reported reactions.....</i>	<i>15</i>
2.1.19	<i>Problems reaching convergence and understanding ATENA convergence parameters.....</i>	<i>16</i>
2.1.20	<i>Can I model a steel structure in ATENA?.....</i>	<i>16</i>
2.1.21	<i>When I model the reinforcement, do the bars and stirrups have to be in geometric connection (with common intersection points) or they can be modeled according to their axis so that they do not touch one the other in geometric sense?.....</i>	<i>17</i>
2.2	How to ... ?.....	18

2.2.1	<i>Is there an example how to change the structure during analysis to consider the construction process?</i>	18
2.2.2	<i>How to model carbon or glass fibre wrap (CFRP, GFRP) strengthening in ATENA?</i>	19
2.2.3	<i>How can I model Fibre Reinforced Concrete (FRC, UHPC, SHCC) in ATENA?</i>	21
2.2.4	<i>I want to use the user-defined stress-strain law of concrete to replace that used in ATENA program. How can I do it?</i>	22
2.2.5	<i>How to model bonded post-tensioning cables in ATENA?</i>	24
2.2.6	<i>How do I calculate the reinforcement ratio when defining smeared reinforcement?</i>	24
2.2.7	<i>How to include confinement in the analysis?</i>	25
2.2.8	<i>How can I include the influence of shrinkage?</i>	26
2.2.9	<i>How can I apply thermal loading?</i>	26
2.2.10	<i>How can I take the bending and/or shear contribution of reinforcement bars into account?</i>	26
2.2.11	<i>How can I take reinforcement bond into account?</i>	28
2.2.12	<i>How can I model a pull-out experiment?</i>	28
2.2.13	<i>How can I model masonry?</i>	30
2.2.14	<i>I have problems when using the Interface (GAP) material on contacts</i>	31
2.2.15	<i>How to model a load combination, e.g., a constant vertical force during horizontal displacement applied until failure?</i>	32
2.2.16	<i>How can I model a compression-only support with nonlinear springs?</i>	33
2.2.17	<i>The analysis runs too long. How can I speed it up?</i>	33
2.2.18	<i>My analysis results do not match the experiment/expectations. How can I improve my model?</i>	34
2.2.19	<i>How can I monitor a surface (or line) load?</i>	34
2.2.20	<i>How can I see the numerical values of monitors and export them into a spreadsheet?</i>	35
2.2.21	<i>How to get the nodal forces at 100 nodes as output in text-file or other?</i>	36
2.2.22	<i>How to detect a structural collapse or ultimate load capacity</i>	36
2.2.23	<i>How to continue (restart) the analysis from a calculated step?</i>	37
2.2.24	<i>ATENA only offers translational supports. How to specify conditions for "hinge support" (rotations) or block all rotations at the end of a column?</i>	37
2.2.25	<i>How can I import the geometry from my CAD / the model from my other FEM?</i>	38
2.2.26	<i>How can I model cyclic or fatigue loading?</i>	38
2.2.27	<i>How can I model pre-stressing losses?</i>	39
2.3	<i>Older issues</i>	39

2.3.1	<i>Problems in Windows Vista</i>	39
2.3.2	<i>Principal strains in 3D material models may show wrong values in the post-processor</i>	40
2.3.3	<i>Principal stresses in 2D material models may show wrong values in the post-processor</i>	40
2.3.4	<i>Problem with some very old parallel hardlocks in ATENA 3.3.0</i>	40
2.3.5	<i>Return algorithm of the plasticity model has changed in version 3.3.0</i>	40
2.3.6	<i>CC3DNonLinCementitious3User material changed in version 3.2.5</i>	40
2.3.7	<i>CC3DCementitious material and CC3DNonLinCementitious materials may show stronger behaviour in version 2.0.1</i>	40
2.3.8	<i>Fatigue analysis gives different result since version 5.1.3 or 5.3.1a</i>	41
2.4	<i>ATENA Kernel Messages and Problems</i>	41
2.4.1	<i>Out of memory error during ATENA analysis</i>	41
2.4.2	<i>I get the message "The execution is killed due to violation of stop iteration criteria", what does it mean?</i>	41
2.4.3	<i>I get the message "Warning: Node NNN dof D has probably excessive value XXX.XXX used in element id: EEE, group id: GGG, name: ..."</i>	42
2.4.4	<i>I get the warning "Invalid master-slave" during analysis, what is wrong?</i>	42
2.4.5	<i>During calculation I get the warning: "Redundant (needless) LHS BCs detected for the following u (node_id, do_id): they will be ignored. " or "Warning: Attempt to constrain slave/use master non-active or zero dof: ... constraint ignored."</i>	43
2.4.6	<i>Floating point problems - Division by zero, Loss of >7 digits on the matrix diagonal, CCFEModelExc: CCPardiso solver error: zero pivot, Warning: Sign of diagonal changed when reducing equation, Floating point exception: Multiple floating points traps, Zero or negative jacobian, InvertA: zero determinant, CCMaterials Extended AExc: CC5ParamYield F: project_stress_on_f_division by zero, and similar</i>	43
2.4.7	<i>I get the warning "Convergence criteria (within line search) not satisfied due to eta limit, continuing super-ordinate iteration" during analysis, what does it mean?....</i>	44
2.4.8	<i>I have this error: CCINPExc: Illegal real number 0, line N, file ..., data being processed</i>	44
2.4.9	<i>CCInpFExc: Syntax error reading ATENA input, line: N, file: ...</i>	44
2.4.10	<i>CCMaterialExtendedAExc: FC0 greater then FC in material (material X)</i>	45
2.4.11	<i>I get a message that I can't understand: Shell/plate macroelement X contains more then a single layer of elements in the direction of the local Z axis</i>	45
2.4.12	<i>Hardware key not recognized (HASP – required key not found, invalid user id check, ATENA only running in Demo mode, or similar)</i>	45
2.4.13	<i>Problem with Network Key</i>	46
2.4.14	<i>Problems upgrading a HASP Key</i>	49
2.4.15	<i>I get the warning: "Zero RHS vector", what is wrong?</i>	50

3	ATENA ENGINEERING.....	51
3.1	ATENA Engineering (general).....	51
3.1.1	<i>How to apply cyclic load?.....</i>	<i>51</i>
3.1.2	<i>Display problems with "Desktop Composition" in Windows Vista/7.....</i>	<i>51</i>
3.1.3	<i>The analysis stops with the message "Error when saving results External exception E06D7363".....</i>	<i>52</i>
3.1.4	<i>Garbled text in some dialogs.....</i>	<i>52</i>
3.2	ATENA Engineering 2D.....	52
3.2.1	<i>Error messages during analysis: Canvas does not allow drawing, Invalid pointer operation, or Control 'PN_Middle' has no parent window.....</i>	<i>52</i>
3.2.2	<i>Only X stresses/strains displayed during analysis.....</i>	<i>52</i>
3.3	ATENA Engineering 3D.....	52
3.3.1	<i>Problem restoring minimized ATENA 3D window.....</i>	<i>53</i>
3.3.2	<i>Problem creating an opening (More than two surfaces are connected to the edge n.XX!).....</i>	<i>53</i>
3.3.3	<i>Problem meshing geometry created in older ATENA versions.....</i>	<i>53</i>
3.3.4	<i>I have a bug; when I click on the button Generate in order to generate the mesh, I get the following error: CCFEModelGenerateExc: T3D generator error code: 10 Source line: 157, file: ..\..\Sources\T3d\atena_cpp.cpp, last modified at: Fri Nov 19 13:5139 2010</i>	<i>53</i>
3.3.5	<i>When I try to run the analysis, I get the "Illegal element type specified for the shell/plate macroelement x (quadratic brick)". This error is given for all the shell elements I used.....</i>	<i>54</i>
3.3.6	<i>When starting the analysis, the message "CCFEModelExc: Can not create contact elements on Contact (contact XXX)! Refine mesh in the neighbouring macroelements" appears.....</i>	<i>54</i>
3.3.7	<i>How can I apply triangular or trapezoidal load in ATENA 3D?.....</i>	<i>55</i>
3.3.8	<i>Problems with nonplanar surfaces, joints not inside macroelements, etc.....</i>	<i>55</i>
3.4	Older ATENA Engineering issues.....	55
3.4.1	<i>When I start ATENA 2D or 3D in Windows 8.1, I get error messages complaining about "COUNTRYSIGNTOINT – invalid COUNDRYSIGN value".....</i>	<i>55</i>
3.4.2	<i>Problem/Fix for ATENA v3.3.0 installation.....</i>	<i>55</i>
3.4.3	<i>Mesh generation errors for some macroelements.....</i>	<i>56</i>
3.4.4	<i>Problems with models involving springs.....</i>	<i>56</i>
3.4.5	<i>Problem with automatic creation/deletion of interfaces.....</i>	<i>56</i>
3.4.6	<i>Dead weight was not correctly applied in analysis in ATENA 3D 4.1.x.....</i>	<i>56</i>
3.5	SARA.....	56
3.5.1	<i>SARA Studio 3D can not start ATENA analysis.....</i>	<i>56</i>
3.5.2	<i>SARA Studio does not work with ATENA 5.0.0 pre-release.....</i>	<i>56</i>

4	ATENA SCIENCE.....	57
4.1.1	<i>Numerical problems with temperature dependent material properties (Fire or other thermal load).....</i>	57
4.2	ATENA-GiD.....	57
4.2.1	<i>Some GiD models and examples need to be transformed - Error in line 2 at C:\xxx\yyy.gid\yyy.uni system ATENA_SI_MN_AND_M is not defined.....</i>	57
4.2.2	<i>During model transformation, the unit system is changed to the default (m, ATENA_SI_MN_AND_M).....</i>	58
4.2.3	<i>My working screen is black and I can not change it. Other display problems in GiD</i>	58
4.2.4	<i>Problems with GiD license, USB or network floating.....</i>	58
4.2.5	<i>GiD claims: You don't have assigned Material 0 at Element xxxx For first number of unassigned element see *.dat file.....</i>	58
4.2.6	<i>Message in line number 63. error: Materials "CCShellMaterial" and "CCBeam3DMaterial" are permitted only for Element Hexahedron.....</i>	59
4.2.7	<i>I have an error when I try to edit the material properties in GiD: Error: can't set ::ttkcb_int__gid_material3_level_combo": can't read "GidData(MAT,,numprop)": no such element in array.....</i>	59
4.2.8	<i>I can't display the results on Contacts in AtenaWin or ATENA Studio.....</i>	60
4.2.9	<i>During analysis start/.inp file creation, I get errors like: ',8m' Expected identifier at position 1.....</i>	60
4.2.10	<i>During analysis start/.inp file creation, I get errors like: Error: Non-signed(nondeefined) element type! and Info: Unknown element type was written to inp file. Find "Unknown element type" in inp file.....</i>	60
4.2.11	<i>GiD gives the following warning while meshing: Condition 'Reinforcement_Elems_Identification' has flag 'on body elements' and maybe it needs flag 'on face elements' in the .cnd file in the problem type.....</i>	61
4.2.12	<i>A GiD dialog does not open when I click the corresponding icon or menu item</i>	62
4.3	AtenaWin and AtenaConsole.....	62
4.3.1	<i>I have an ATENA Input File (.inp), how can I start the analysis in AtenaWin or AtenaConsole or ATENA Studio?.....</i>	62
4.4	ATENA Studio.....	64
4.4.1	<i>After returning from Turbo mode or restoring a saved layout, not all windows are restored.....</i>	64
4.4.2	<i>Can not read results for postprocessing - CCEXception: An error during serialisation of the model CCStructures.....</i>	64
4.4.3	<i>ATENA Studio does not start.....</i>	64
4.4.4	<i>How can I check the local coordinate system of elements?.....</i>	65
	References.....	66

1 INTRODUCTION

This document is intended as a reference for frequent error and warning messages, and solving general common problems occurring while using the software. First, general messages and problems are handled, followed by program specific issues structured according to the parts of the software package (user interfaces).

2 GENERAL QUESTIONS, MESSAGES, PROBLEMS, AND INSTRUCTIONS

In this chapter, questions, problems (2.1, 2.3), and how-to solutions () which are common to all ATENA programs are presented.

2.1 General problems

2.1.1 *I have a problem not listed here*

If you experience a problem that is not described here nor in the "Readme" nor in the Frequently Asked Questions / Known Issues on our web [19], please download the latest version of this document from our web: <http://www.cervenka.cz/assets/files/atenapdf/ATENA-Troubleshooting.pdf>. If you have also failed to find an answer or a solution in the manuals, you should try to search our forum at <http://www.cervenka.cz/forum/>. If you still cannot find a solution of your problem, please send us your model (.cc3, .cc2, or .gid, without results, compressed with ZIP, Rar, or another packer; in case of GiD models, we recommend to delete the .bat files from the archive before sending, as these are automatically generated, and get frequently rejected by email servers or antivirus programs, classified as executable files) by email to: [cervenka \(at\) cervenka \(.\) cz](mailto:cervenka(at)cervenka(.)cz). For ATENA Engineering 3D models, it usually helps if you delete the mesh (but not the mesh settings - the fastest way is to change the global element size, press OK, and change it back). If the file is still too big for email, you can send it using some file transfer service (UlozTo, WeTransfer, or similar).

In your email message, please indicate the name of the program, the program version that you are using, your licence number (ATENA WR, which can be found for instance under user ID in the **About** dialog in **ATENA Engineering** version 4.3.1 and older, or under the colour scale in the **ATENA Studio** structure window in v 5.0.1 and later; currently (version 5.6.1), you can also find the WR and license name in the **About** dialog of **ATENA Studio**, see Fig. 2 -1), and a short description of the problem. Include a sketch and/or photo of what you are modelling whenever possible. Include any error or warning messages as text or screenshots (best attached as .png files, which are more effective than .jpg for this purpose, and comfortable to handle than pictures embedded in documents).

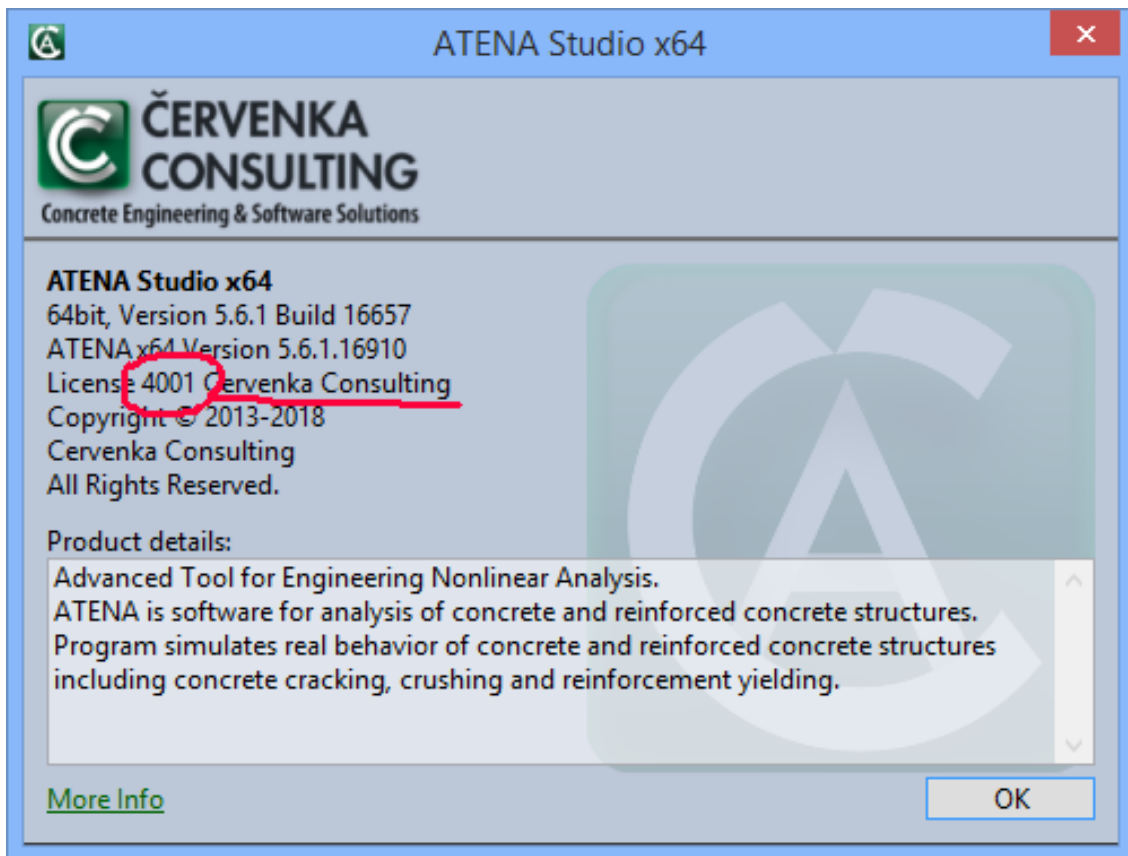

Fig. 2-1 ATENA Studio About dialog with emphasized WR and license name

2.1.2 What is ATENA?

ATENA is a totally new generation of our program **SBETA**. **ATENA** is a fully windows program with integrated pre- post-processing and finite element solution. The post-processing and pre-processing is improved significantly. In addition, it contains many new materials, solution methods and other capabilities as for instance options for 3D, plane strain, axi-symmetrical analysis or shell elements. You can learn more about **ATENA** on our **ATENA** page. The name **ATENA** is an abbreviation for **Advanced Tool for Engineering Nonlinear Analysis**.

2.1.3 What is SBETA?

SBETA was our very first product developed in 80's for DOS operating system. It was a first user friendly non-linear FE software package on the market for non-linear finite element analysis of concrete and reinforced concrete structures. It could have been used to analyse beams, walls, reinforcing details and all other civil engineering structures, which could be idealized as two-dimensional problems.

2.1.4 Can I analyze 3D structures with ATENA?

Yes, **ATENA** version 3 and later can be used to analyse 3D structures in a native graphical environment of **ATENA Engineering 3D** (see [3]). In addition, since **ATENA** version 4, scripts for interfacing the **ATENA** software with the general purpose finite element pre- and post-processor **GiD** (versions 8 to 11) are part of the

standard ATENA installation (**ATENA Science**, see [16]). Scripts for interfacing **ATENA** with **FEMAP** version 7 (see [12]) are available upon request.

2.1.5 Are there any solved examples?

There are a few tutorials in PDF format in the Documentation subdirectory [6], [7], [8], [9], the corresponding models and many other example models are installed into the Examples\ subdirectory, typically,

c:\Program Files\CervenkaConsulting\AtenaV4\Examples\ (ATENA v4)

or

c:\Users\Public\Documents\ATENA Examples\ (ATENA v5).

The most important ones are described in the Example Manuals [4], [5]. Some of them are also included in Demo installation, which anyone can download and try.

2.1.6 I plan to buy a new PC to run ATENA on it, what do you recommend?

2.1.6.1 Video card

First of all, we do not recommend integrated graphics systems (e.g., Intel 965) - the OpenGL drivers are often that bad, that normal use of **ATENA**, **GiD**, or CAD in general is not possible. We recommend video cards targeted for CAD users (e.g., nVidia FX series, ATI FireGL/FirePro series). "Game cards" work with small restrictions in most cases (see 2.1.14 for details).

GPU cores (CUDA) can not be used for the analysis so far, and this is not planned for close future.

2.1.6.2 Memory

Up to version 4.2.7, **ATENA** can only use max. 2GB (as all 32bit programs, also in 64bit OS), therefore we recommend 2-3GB RAM for single-core processors, but nowadays, dual- or quad-core processors make more sense anyway. One can then run 1 (or 3) analyses simultaneously and prepare or post-process another model at the same time. Attention has to be paid to the memory access speed - with dual channel Chipsets one has to have identical modules in the corresponding slot pairs, otherwise the system can slow down a lot (we have once had a quad-core with mixed memory modules and 2 analyses at a time were already slowed down by waiting for the memory, after upgrading to 4x 2GB four analyses run nicely).

Since version 4.3.1, x64 versions of AtenaConsole and AtenaWin are available (+ **ATENA Studio** since v5). **ATENA Engineering** (2D, 3D) remain 32-bit only. If you plan to work with large models in **ATENA Science**, 32GB RAM can make sense - the physical RAM is usually the limit for large models (more RAM makes it possible to solve a larger model, not improve speed for small ones).

2.1.6.3 Processor

Since version 5.1.1, multiple threads can be used for a single analysis, however, according to our experience with 4- and 6- core CPUs (8 and 12 instruction queues due to hyper threading), for large models, the speedup is almost 2 for 2 threads and about 4

for 8 threads (for small models, the parallel speedup gets even smaller, if any at all). Therefore, if you can choose between a 4-core and a 6-core CPU with about the same CPU benchmark score, we recommend to get the 4-core one.

The fastest and most expensive processors do not pay off in most cases, but the cheap models (Celeron from Intel and similar from AMD) are generally not good for numerical tasks (slow FPU, small cache).

2.1.6.4 Disk

Recently, we have good experience with hybrid disks (SSHD, combining, e.g., 500GB HDD and 8GB SSD used as kind of cache).

2.1.6.5 Efficient modelling

Finally, of course, please do not forget that reducing the model as much as possible, like using symmetry (only modelling 1/2, 1/4 or 1/8, or even 2D or rotational symmetry when possible), "smart" meshing (only refined where needed), etc., usually make much more difference in the analysis running time than different computers – see section 2.2.17 The analysis runs too long for tips.

2.1.7 *Can I run ATENA on Linux? Can I install it on my Mac with OS X?*

As of version 5.0.3, ATENA can only run on Windows OS (recommended: 64-bit W7), and versions for other operating systems are currently not in development. That means the only way to run ATENA on Linux or OS X or other OS is an emulator like Wine or some virtual machine with Windows (e.g., W7 installed in VMware or VirtualBox or similar). Attention has to be paid to the HASP HW keys, the corresponding drivers have to be installed both for the host OS (HASP drivers for Linux can be downloaded from the Safe-Net web) and in the virtual machine (the ones from the ATENA CD or the latest from the web).

If you work in Apple OS X, using dual boot into Windows is the most efficient way of installing ATENA on your Mac from the point considering the RAM and CPU power available for running analysis.

2.1.8 *I understand the 'fixed crack model coefficient' switches between fixed and rotated cracks. Standard the value is 1, but what does that mean?*

In the NLCem2 material family, the **fixed crack** value determines at which max. residual tensile stress level the crack direction gets fixed. In other words, 0.0 means fully rotated crack model, 1.0 fixed since cracking start (see section 2.1.6 Two Models of Smeared Cracks in the SBETA material description in the ATENA Theory Manual [1]), values between 0.0 and 1.0 determine the level, e.g., 0.7 fixes the crack direction as soon it opens so far that the softening law drops to 0.7 times the [initial] tensile strength.

We generally only recommend to use (partially) rotated cracks for very large finite elements (shells) subjected to load of changing direction.

2.1.9 Does the non linear analysis of ATENA consider the geometrical nonlinearity (second order effects, like buckling or necking)?

A short answer: yes.

A more detailed one: in **General data | Analysis information | Solution** you can check/uncheck a box named "Geometrically nonlinear analysis" (**ATENA Engineering 3D**). In **ATENA-GiD**, you can select **LINEAR** or **NONLINEAR** for **Geometrical Non-Linearity** at the **Element Geometry** tab of the **Material** dialog. If enabled, the equilibrium on deformed geometry is considered even during each iteration. If disabled, the geometry from the end of the previous load step is used during the iterations. For short load steps, the setting does not change much.

This means second order effects, like buckling, are of course (automatically) taken into account. In other words, if you model the classical Euler beam with compressive load, you get the expected response - when the force gets close to the critical value, the deformation starts to increase rapidly.

In case of (even just locally) large deformations, sometimes the numerics runs better with linear (stable deformations from last step, time saved updating in each iteration), sometimes the nonlinear works better (each iteration costs more, but good balance may be found faster at the end).

2.1.9.1 Reinforcement buckling

For 1-D reinforcement bars and cables, which only have axial stiffness, buckling can not be precisely considered the same way as for the other element types (i.e., implicitly through the geometry, as explained above). You can disable the "Active in compression" box to account for buckling. In most situations, this simplified approach works well (and the results are on the safe side).

Bars "through the air"

If you have a bar passing "through the air" between 2 volumes, please keep in mind it can only transfer tension. Compressive load typically results in lateral displacement (if not blocked by other means) – as the bar has no bending nor shear stiffness and the axial length change is negligible, such a segment provides no resistance in compression (see also 2.2.12.3). One can see this as ideal buckling being considered for bar segments not embedded in any volume material.

2.1.10 The tensile (or compressive) stresses exceed the tensile (or compressive) strength or yield stress – what is wrong?

2.1.10.1 Extrapolation

In most cases, this is due to extrapolation from integration point to the surface (nodes). This is usually observed in regions with steep gradients, and can be 30% or similar, see Fig. 2 -2 for an example. You can look at the values at integration points (select **in internal points** and **show and label** in the tensor results options).

The extrapolation settings for displaying the values in nodes and element nodes can be changed, but only in **AtenaWin/AtenaConsole**, and not directly in **ATENA 3D** - you can export the step results to a binary file (**Data | Results manager | Export results**), load the file into **AtenaWin (Application | Restore FE Model from)** or **ATENA**

Studio (Create new project from result files), change to use the value from the nearest integration point instead of extrapolation (**Output | General Options | Recovery strategy | Nearest MP**, click **Apply** and then **Cancel**, store the results again (**Application | Store FE Model to** in **AtenaWin**, or through the **Steps Manager** dialog in **ATENA Studio**). Then you can read it back into **ATENA 3D (Files | Open other | Results by step)**.

In **GiD**, it is also possible to switch to the nearest point inter-/extrapolation before starting the analysis using the checkbox **Extrapolation Nearest IP** at the **Global Options** tab of the **Data | Problem Data | Problem Data** dialog.

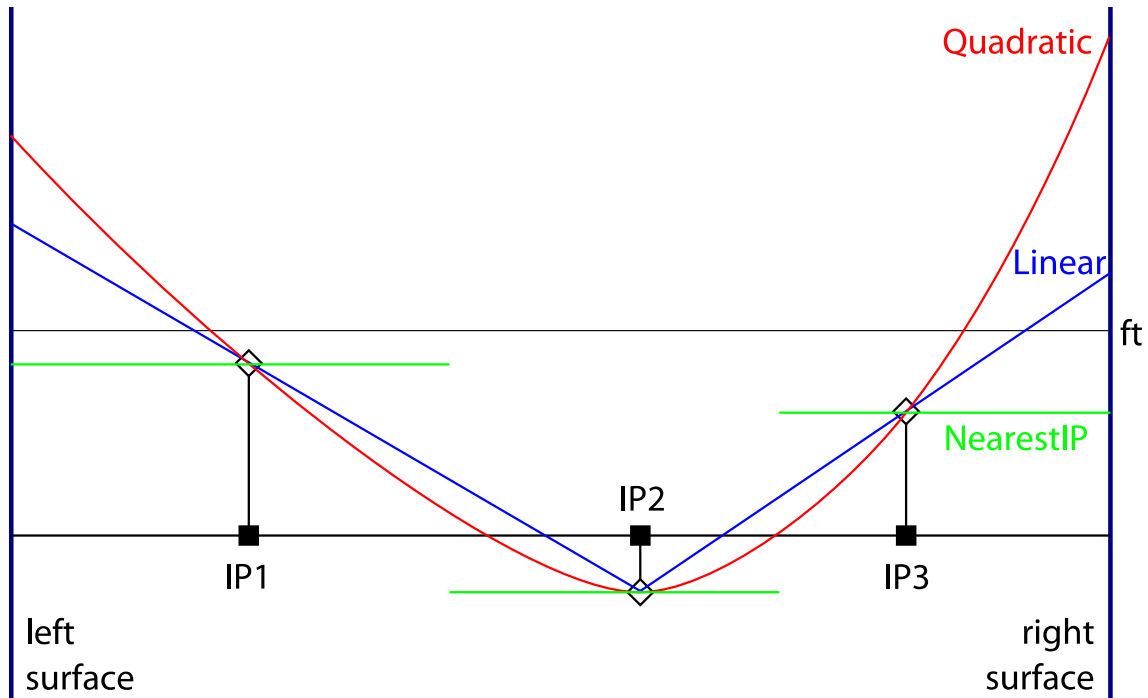

Fig. 2-2 Example comparison of several ways of interpolation

2.1.10.2 Confinement

In case of compressive stresses higher than the compressive strength or when there are no plastic strains while the yield stress is exceeded, this is usually a consequence of confinement. The effect is similar for concrete under compression and steel (both compression and tension).

If there is compression (or tension in case of von Mises material) in 2 or 3 directions (i.e., 2 or 3 stresses have the same sign), the maximum stress is larger than the uniaxial compressive strength (or yield stress). For details, see section 2.2.7 and/or the failure surface shape in the right figure at the **Basic** tab of the **Steel von Mises** material dialog and/or the Theory Manual.

2.1.10.3 Nonlinear geometry

You may sometimes observe that the **Von Mises Stress** (e.g., for bilinear steel with zero hardening) exceeds the **yield stress**.

The reason for this discrepancy is the activation of the geometric nonlinearity in your model. If the geometric nonlinearity is on, then the program after each step converts the stresses according to the new updated deformed shape. This may result in the small violation of the material criteria (Von Mises), which is then corrected during the next step. To be subsequently again distorted at the end of the next step.

Actually, the geometric nonlinearity is necessary only if you assume to have large displacement/strain increment in a single step. Even if the geometric nonlinearity is deactivated, the program updates the coordinates during the deformation process so the geometric nonlinearity is captured as well as long as small load steps are used.

So the solution to your problem is to turn off the geometric nonlinearity. This is done in the **General Data | Analysis information | Solution** (in **ATENA Engineering 3D**).

2.1.11 Unrealistic damage near loading/support plates during shrinkage or pre- or post-tensioning

During the application of shrinkage (see also 2.2.8) or pre-stressing or post-tensioning (see also 2.2.5), unrealistic cracks (or other damage) may sometimes develop near the support or loading plates. To avoid or reduce these effects, the following measures are recommended (simplest first):

1. Apply the same amount of volume change (shrinkage) also into the plates. In case of reinforcement located near a plate, you may need reduce the volume change applied to the plate for best results.
2. Use contact elements (GAP, Interface, see also 2.2.14) to connect the plates to the concrete.
3. Add the plates after the shrinkage using Construction process.

2.1.12 Strange deformations in a corner or on an edge

If you experience unexpected displacements (deformed shape) of some corner(s) or points on an edge where different boundary conditions of the same type intersect, please make sure you assign the correctly composed boundary condition to the edge line or corner point.

Example: 2 surfaces, one supported in X, the other in Y. Assign support in both X and Y directions to the edge common to both surfaces, see Fig. 2-3.

Background: if the proper condition is not assigned to the intersection, the ATENA kernel selects one of the 2 conditions for each node at the intersection (and it is not easy to tell in advance which of them).

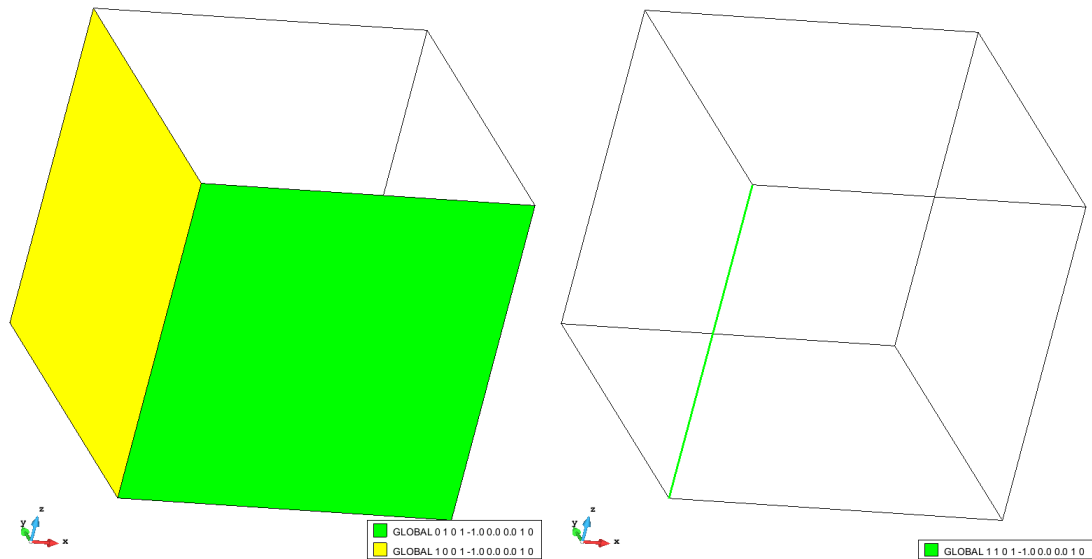

Fig. 2-3 Example of conditions intersecting on an edge (recommended definition)

2.1.13 A monitoring point shows no value, the program gives me an error on reading a monitor value

The 2 most frequent problem sources related to monitoring in a model are the following:

1. There is no Reaction in a point where an external force is applied. Define a monitor for **External force**. On the other hand, in case of prescribed displacement (or a support), define the monitoring point to record **Reaction**.
2. The monitor has to be defined at the same point where the support or load is applied.

2.1.14 Problem with some graphics drivers

Some nVidia graphics cards (and other, generally, gaming/office cards) do not work correctly (errors e.g. in rendering the colour scale). For correct display, keep/return to the nVidia 7.x.x.x drivers or decrease the HW acceleration to max. the 2nd position "Disable all but basic accelerations" with drivers 8.x.x.x, 9.x.x.x, and 16x.xx, including 182.50 (6.14.11.8250).

Graphics cards designed for CAD, e.g., nVidia FX series or ATI FireGL/FirePro series, are recommended for ATENA (see also 2.1.6 I plan to buy a new PC to run ATENA on it, what do you recommend?).

2.1.14.1 Video cards switching

If you have a system with both integrated graphics ("energy saving") and discrete ("performance"), we recommend disabling the automatic switching and permanently enabling the discrete card while working in ATENA or GiD. This is usually done in the NVIDIA Control Panel or ATI/AMD Catalyst Control Center, and can be set either globally, or per application - if so, please select the "performance" card for ATENA Studio (both 32bit and x64), ATENA 3D, ATENA 2D, and GiD (you may also set it for AtenaWin if you are using it; don't expect this setting to have any influence when set

for ATENA Update Check or AtenaConsole). You may need to update your drivers to the latest version from the manufacturer's site to get this option working.

2.1.15 Sometimes, after lot of editing, an error message appears

In this case it is recommended to save your data and start the program again. In most cases this error does not result in any loss of data.

2.1.16 Some materials do not support Tangent predictor

Some materials do not support Tangent predictor. Elastic stiffness is used instead. This concerns the following material types: CC3DCementitious, CC3DNonLinCementitious where the tangent stiffness is supported only for cracking. CC3DBiLinearSteelVonMises, CC3DDruckerPragerPlasticity where the tangent stiffness is not supported at all.

2.1.17 It is not possible to read results created with version 4.x.x or 1.2.3 and older of the program

It is not possible to read results created with version 1.2.3 and earlier of the program. A similar change of the results data format has also occurred between versions 4 and 5. Only input data are backward compatible, which means it may be necessary to re-generate the mesh and re-calculate old data when new version of the program is installed.

2.1.18 Wrongly reported reactions

Reactions are always correctly calculated but they can be wrongly reported in the post-processor in case of:

- inclined supports - only one component of the reaction is shown
- for supports close to the reinforcement, part of the reaction that goes into the reinforcement rod is not shown, but it will appear in the textual output in the node that belongs to the reinforcement and is close to the support condition.
- reaction at a joint which connects two regions will contain the reaction force only from one region and not the other. This may be especially a problem in case of load-displacement diagram monitoring. It is recommended not to monitor reaction or forces at geometrical joints that belong to more than one region. If it is necessary then the reaction force should be monitored at all nodes with identical coordinates. The total reaction can be then obtained by their summation.

Correct reaction forces can be verified from the text output of the **REACTIONS**. This problem was partially fixed in version 1.1.3, but full fix exists in version 1.2.2. In this version there are two types of reactions:

- **PARTIAL_REACTIONS** - some forces appear to be missing, but they can be found in other nodes that are constrained with the node, where the support is applied.
- **COMPACT_REACTIONS** - these are the reactions that you will be using most of the time. They are not modified by the various constraints due to for instance reinforcement or others.

2.1.19 Problems reaching convergence and understanding ATENA convergence parameters

It is important to check the convergence process in **ATENA** during the nonlinear analysis. The characteristics about the convergence process are best seen in the message/log file. In typical situation this is the file with the extension ".msg". Alternatively this can be verified using the special monitors in **ATENA Studio** command **View | Pre-defined diagrams** (in **ATENA Engineering** the message file content is accessible using the command **Data | Analysis progress information** from the post-processing window). There are four convergence criteria available:

- Criterion 1 - Relative error in displacement
- Criterion 2 - Relative error in residual forces
- Criterion 3 - Absolute error in residual forces
- Criterion 4 - Relative error in energy, i.e. basically a product of relative residual error and displacement error

The provided error measures are relative. This means that for instance a value of 0.03 for the criterion 2, means the error in the force equilibrium of 3%.

If after the analysis, there are many steps where the maximum number of iterations was reached, it is important to understand that a significant error can be expected in the obtained results. The amount of the error can be estimated based on the highest error in these four criteria at the end of the step. However, it should be understood that the real error could be larger than the provided estimate. In general, if there are errors >10% in several steps in a row, the results are not reliable. On the other hand, a single step with error about 2% is absolutely no problem in most cases.

There are several ways how to improve the convergence. Our recommendation is to try the following measures one after another as long as the problem persists:

- (1) check the deformed shape of the model to verify that the model behavior corresponds to the expected one. If not verify the applied loads, boundary conditions, material parameters, etc.
- (2) change the solution parameters for the problematic steps to **Stiffness type: Elastic predictor, Update stiffness/Assemble Stiffness: Each step**. This effectively means using modified Newton-Raphson method with initial stiffness rather than the default tangent stiffness.
- (3) reduce the step size for the critical steps or use the solution parameters: "Repeat No Converged Step" (This parameter is available only in **ATENA Science/GiD**).

See also 2.2.22 on detecting structural collapse in the analysis and 2.4.2 on conditional break criteria.

2.1.20 Can I model a steel structure in ATENA?

The primary target of **ATENA** is modeling the behaviour of concrete (including reinforced and pre-stressed) and similar materials, and the steel material models are intended for reinforcement (1-D bars, smeared) and smaller steel parts (von Mises). We agree other software packages are better/more comfortable for nonlinear analysis of steel structures, however, in some situations, modeling large steel members or even a

steel structure can make sense. In that case, it is good to know the limitations and how to overcome them (see 2.2.6 and 2.2.10 for more information on modeling reinforcement). Buckling and other effects of nonlinear geometry are implicitly considered in the analysis.

The main restrictions and their workarounds are the following:

2.1.20.1 Bilinear material model

The volume material for steel in **ATENA**, 3D Bilinear von Mises, only supports bilinear laws (ideal plastic or with hardening). There is no limit strain, which means exceeding it has to be verified in post-processing. Due to confinement effects (see also 2.1.10.2 and 2.2.7), checking the stress to determine failure is not a good idea. Comparing the max.+min. principal plastic strain in the steel to an ultimate strain value is probably the simplest way to determine failure (identify the last load step before exceeding the ultimate). We recommend defining Min.+Max. monitors to be able to follow it already during the analysis.

2.1.20.2 Too many mesh elements

If you need to model a larger steel structure, volume elements can easily require extreme amounts of memory and time (keep in mind 4 elements per thickness are about the minimum for bending regions!). Therefore, you probably need to model most of your structure with the threaded beam elements (only available through the **ATENA-GiD GUE** of **ATENA Science**, see **ATENA-GiD User's Manual** [16], 5.3.3 Beam Material) or shell elements (see **ATENA-GiD User's**, 5.3.2 Shell Material or **ATENA Engineering 3D User's** [3], 3.7.2.2.7 Shell Macroelements).

2.1.21 *When I model the reinforcement, do the bars and stirrups have to be in geometric connection (with common intersection points) or they can be modeled according to their axis so that they do not touch one the other in geometric sense?*

In short: unless you observe unrealistic damage in the concrete between the 1D bars, place the reinforcement elements according to their real positions, i.e., 1D reinforcement located at the axis of the real bar.

Background:

1. As the 1D bars only have axial stiffness, connections of perpendicular segments only have limited influence.
2. All reinforcement nodes inside a single finite element of the surrounding material get automatically connected to the same nodes (although not with identical weights), which effectively connects them. If they are located inside 2 neighbouring finite elements, they are still linked to about 1/2 of the same Master nodes.

If your mesh in the concrete is so fine that a whole element falls between the 2 reinforcement nodes (i.e., edges length < bar diameter), you might indeed get unrealistic cracking between the bar and the stirrup, however, in that case modelling concrete as a homogeneous continuum is probably already questionable...

You may also be interested in reading about considering bending/shear contribution of bars in section 2.2.10.

2.2 How to ... ?

This section contains instructions how to model specific structures, experiments, materials, loadings etc., or how to get specific output.

2.2.1 *Is there an example how to change the structure during analysis to consider the construction process?*

In **ATENA Engineering 3D**, modelling construction process is pretty straight forward and explained in section 3.8.2.1 Construction cases of the ATENA 3D User's Manual [3]. For **ATENA Science** and **Engineering 2D**, there are tutorials included in the installation (section 2.2 Tutorial for Construction Process in [5]

(..)\AtenaV4\Documentation\ATENA Science\ATENA-Science_Example_Manual.pdf

or

(..)\AtenaV5\Documentation\ATENA Science\ATENA-Science_Example_Manual.pdf

and [8]

(..)\AtenaV4\Documentation\ATENA Engineering\ATENA-Engineering-2D_Tutorial_Construction_Process.pdf

or

(..)\AtenaV5\Documentation\ATENA Engineering\ATENA-Engineering-2D_Tutorial_Construction_Process.pdf.

In ATENA version 5, there is also the new

(..)\AtenaV5\Documentation\ATENA Science\ATENA-Science-GiD_Tutorial_ConstructionProcess.pdf.

If you work with **GiD**, see the description of the following **Conditions: Elements activity**, **Reinforcement Inactivity**, and **Boundary Reactions for** in ATENA-GiD User's manual [16], 5.2 Conditions, and also **Material activity** in 5.4 Interval Data - Loading History and the option **Application from Interval** on the **Element Geometry** tab of the **Reinforcement material** dialog.

2.2.1.1 Notes and restrictions

In general, it is important to pay attention to a few restrictions while modelling construction process in **ATENA**:

1. The newly added structural member (Macroelement in **ATENA Engineering 3D**, volume or surface in **ATENA-GiD**) has to be connected as Slave in all contacts connecting it to the already existing parts (Master).

2. At the same time, the general rule that the side with the larger finite elements has to be the Master remains valid.

Together, this implies the newly added parts have to be meshed with the same element size as the "old" ones or finer.

2.2.1.2 Variable material as an alternative to Construction Process

When the newly added elements are attached to the already existing parts, the nodes in contact with old elements are moved to the deformed position. This works almost like pouring the fresh concrete mixture into the structure, however, the internal nodes are placed at the undeformed initial coordinates, which makes the surface elements somewhat distorted. If you magnify the displacements later during post-processing, the elements may easily look very deformed, even like turned inside-out.

If this is a problem, there is another option of modelling the construction process, using variable material (NonLinearCementitious2Variable). Define a low elastic modulus (e.g., 1/100 of the value of normal concrete) for the steps before the element is added, and normal E after. However, this approach also has a few catches:

1. The strains may be wrong (which can be partially fixed by adjusting the compressive or tensile properties).
2. If you add or delete some load steps, you may need to adjust the material to let it act at the correct time.

2.2.2 How to model carbon or glass fibre wrap (CFRP, GFRP) strengthening in ATENA?

Adding a thin layer of epoxy (or glue or similar) containing directional carbon (or glass or other) fibres into a model requires special attention. With tetrahedral (or any other volume elements) the thin layers would need a lot of elements (imagine just 4 elements per the FRP layer thickness and 4:1 aspect ratio!). We think this modelling would not be feasible with today's computers...

A better option is to model the CFs as discrete bars at/near the concrete surface, see Fig. 2-4(a). About 2 bars per element (with the area corresponding to the total CF cross section area per the concrete element width) should be enough. However, it is not possible to capture debonding/delamination with this modelling (slip along fibre direction can be considered with Bond for Reinforcement).

Sometimes, especially in case of 2-dimensional modelling, the wrap can also be modelled as a smeared reinforcement layer (see Fig. 2-4(b) and also 2.2.6). The limitations are similar to modelling with discrete bars, i.e., debonding/delamination can not be considered.

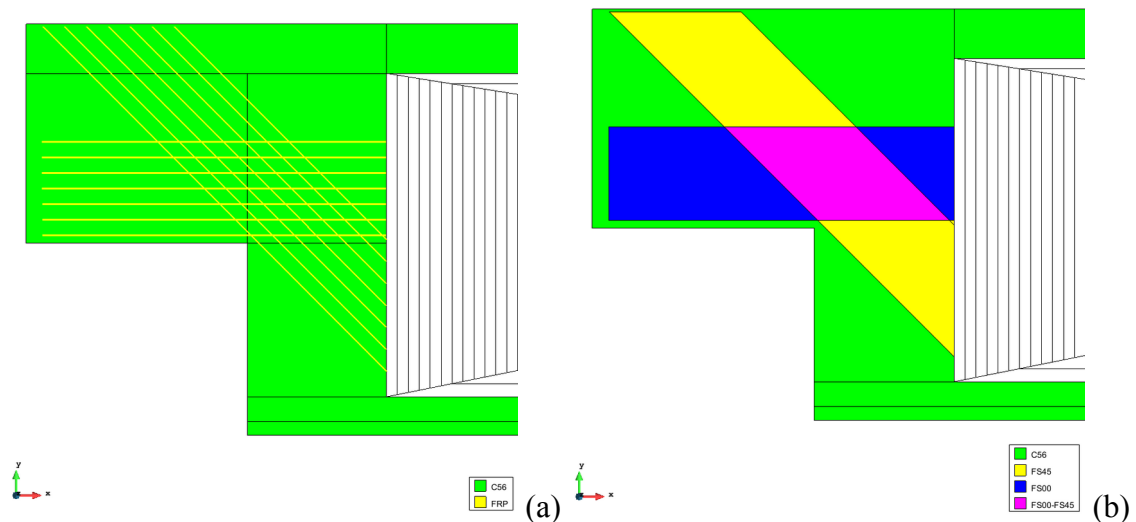

Fig. 2-4 Example of FRP strengthening represented as discrete (a) and smeared (b) reinforcement

Another recommended option is to use shell elements to model the wraps. Then, you can model the interface between the concrete and the wrap using contact (GAP) elements. You assign the properties of the matrix material (epoxy, glue; elastic modelling is often enough) to the shell volume, and add the fibres (usually, a tri-linear working diagram is enough to capture the behaviour of the fibres) as reinforcement layers, a layer for each fibre direction (see also 2.2.6.1).

Please see the Shell elements description in the Manual [3] or [16]. Here, only the most important settings are summarized:

1. For all macroelements that use shell/plate elements, the following has to be set:

1.1. "quadratic" in **FE mesh | Generation**

and

1.2. "brick" in **FE mesh | Macroelements**

2. For pure tension, a 3-4-layered shell is enough, for cases, where bending of the shell has influence, usually 6-10-layered shells are needed to get accurate results.

3. Please pay attention to the wrapped edges - the best connection at edges is a 45 degrees (or a different corresponding angle if the thicknesses are not the same, see the figures in the manual).

It should not matter which surface is top and which bottom, the important thing is that the thickness is defined in the right direction (the smallest one), and as long as the top and bottom surfaces are parallel, both give correct result. However, in corners where 2 FRP elements are connected, I would recommend that these have both the same orientation, i.e., both have "top" to the beam or both "bottom" to the beam.

Additionally, if one defines reinforcement layers in different depths of the shells, it makes sense to have consistent orientation such that the distances from top/bottom have the same meaning everywhere.

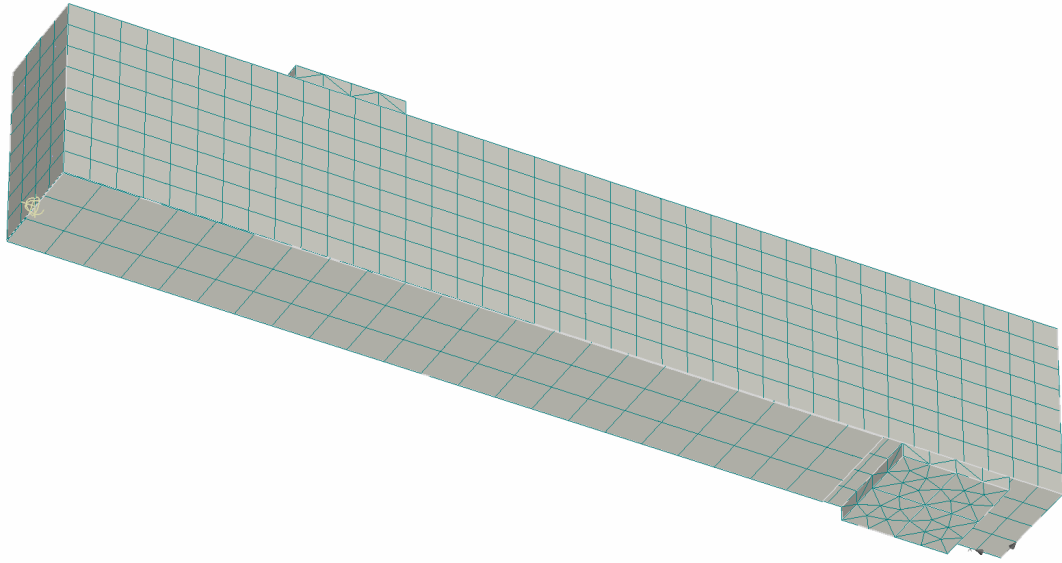

Fig. 2-5 Example of FRP represented with shells – a beam, strengthened at the bottom (modelled symmetric half)

Model precision

If you have problems with nonplanar surfaces or similar while modelling the thin geometry, please see also 3.3.8.

Strengthening after loading

If the strengthening is being added under loading or after unloading, but to a structure which is already damaged, see also 2.2.1.

Tutorial

You may also be interested in the Tutorial ATENA Science – GiD Strengthening of concrete structures [11].

2.2.3 How can I model Fibre Reinforced Concrete (FRC, UHPC, SHCC) in ATENA?

Adding fibres from various materials like steel (SFRC), carbon (CFRC), glass (GFRC), plastic or other into concrete mixtures to improve the material properties is becoming more and more common. There are 3 basic ways for modelling Fibre Reinforced Concrete (FRC) in ATENA (sorted from simplest to most detailed):

1.a. The normal NLCem2 material model with increased fracture energy (G_f , typically $10x - 1000x$) + possibly a few other changes in the material parameter values.

1.b. If you can work in 2D, SBETA offers the most straight forward way. The choice of tension softening laws is quite wide in the SBETA material, and "SFRC" and "SFRC local strain" have been developed specifically for FRC.

2. Representing the fibres with smeared reinforcement.

In 3D, you should define it in 7 directions - the 3 axes + 4 pointing in the middle of the octants; in 2D, 3 should be enough - one axial direction + in a 60 and 120 degrees angle

from it. This modelling is of course not good in capturing the fibre bond influence, but definitely should give you the general response including the strain hardening.

For each layer of smeared reinforcement, you define a reinforcement ratio and a direction. If you assume the fibres' orientation is isotropic, you apply 1/7 of the total reinforcement ratio corresponding to the fibres in each of the 7 directions (in 3D; or 1/3 in each of the 3 directions in 2D). If you wish to take account for the dowel effect of individual fibres, increase the 1/7 by an amount representing this effect of the fibres perpendicular to each direction.

3. The NLCem2User material model (see 2.2.4).

If you have tried 1. or 2. and the results are not good enough, you have to define all the functions for the NLCem2User material.

You may also be interested in the ATENA Science – GiD FRC Tutorial [10].

2.2.4 I want to use the user-defined stress-strain law of concrete to replace that used in ATENA program. How can I do it?

You can use the CC3DNonLinearCementitiousUser2 (NLcem2User) material. We recommend to download the example spreadsheet calculating the points for the tension softening function following the Hordijk law, which can be used to define tensile behaviour close to the CC3DNonLinearCementitious2 (NLCem2) material model, from our web:

<http://www.cervenka.cz/assets/downloads/Atena/HordijkUser.xls> .

Please understand the localization strain and characteristic length are very important. These parameters allow to reduce the mesh dependency in a way analogical to the NLCem2 material. Please see the figure at the right side of the NLCem2User Material dialog, which includes the formula how the char. length is used. For more details, see the ATENA Theory Manual [1].

The following questions may arise when looking at the spreadsheet:

1. How to get "l_ch"? Is it the crack band size?

A possible way of setting the characteristic size L_{ch} and localization strain (loc. onset) is to set the char size to the size of your strain gauge in the calibration experiment or to the element size used in the calibration analysis. The localization onset should be set to the strain at peak stress (for example in some FRC, this max. stress maybe a bit higher than the tensile strength).

Note: you should use the characteristic size from the calibration model even if the mesh size is different in the final analysis. However, you may need to modify the Localization onset (ϵ_{loc}) to reflect the differing element size. Please also remember that as long as the localization onset is not reached, the characteristic size has no influence.

You can read more on the characteristic sizes in the ATENA Theory Manual, above all 2.2.3 Rankine-Fracturing Model for Concrete Cracking (around Fig. 2-20) and 2.2.4 Plasticity Model for Concrete Crushing (around Fig. 2-21).

2. In the material dialogue box how can I calculate the "G/Gc" value in "shear stiffness function" of "shear"?

See the r_g column.

3. *What are the units used in the spreadsheet?*

- the strains (ϵ s) are dimensionless,
- the failure displacement (w) in meters,
- the last 2 columns (σ/f_t and r_g) are dimensionless - they are relative values given as fraction of the initial value.
- the elastic modulus E is in MPa. However, the value there is just an extremely high one left there from some what-if tests.

4. *Is " f_t " the same as uniaxial tensile strength " f_t "?*

Yes, as in Chapter 2.2 (Fracture–Plastic Constitutive Model family).

5. *How to get G_f ?*

The easiest way is to generate an EC2 concrete class close to your mixture (or select one from the database) and copy+paste the fracture energy (G_f) value.

6. *Should I keep the " τ/f_t " value of "shear strength function" be default value?*

Well, if you do not know anything better, you can try the default values as a starting point. Or, follow formula (2.48) in section 2.2.3 Rankine-Fracturing Model for Concrete Cracking of the ATENA Theory Manual.

7. *What's the concrete compression strength used in the spreadsheet?*

The spreadsheet has no relation to compressive strength at all. It only does calculations related to tension and shear.

Other questions related to the NLCEm2User material model:

8. *Does the "compressive strength reduction due to cracking curve" denote the softening part after plastic strain localization?*

No. This function determines how the compressive strength decreases due to cracking in other direction(s) in the same material point. See also the Biaxial failure law figure on the Basic tab of the NLCEm2User dialog.

9. *Can the fracturing strain ϵ_f be calculated by subtracting the total strain of the tested tensile strain-stress curve from the first cracking strain?*

No, total strain = elastic strain + fracture strain, which means the current elastic strain has to be subtracted.

10. *Is the plastic compressive strain ϵ_{pl} calculated by subtracting the elastic strain from the total strain?*

Yes, the current elastic strain is subtracted from the total strain to get the plastic strain (note that the current elastic strain corresponds to the current stress, i.e., it is NOT equal to the elastic strain at compressive strength).

11. *What does strain at localization (Tension Localization Onset) mean?*

The strain where the program switches from the strain-based formula to the “localized” formula - crack width based (using crack band and characteristic length) – see the figure in the Material dialog.

For plain concrete, this is typically zero, for fibre reinforced, one typically sets it > 0 , to be able to represent hardening after the first crack initiates, etc.

2.2.4.1 User Material DLL

If defining the functions in the NLCem2User material are not enough, you can prepare your own library, providing the material response [18].

2.2.5 How to model bonded post-tensioning cables in ATENA?

For unbonded pre-stressing cables, the best way of modeling is typically **External Cable**. For bonded ones, **Reinforcement Bar** with bond (perfect or a bond law). Usually, the error introduced by modelling the bond from the beginning, i.e., before applying the pre-stressing, is not large - we definitely recommend to proceed that way first. Of course, if there are problems, typically, unrealistic bond damage due to pre-stressing, more complicated modelling options need to be considered – see the option **Internal Cable** in the **Geom Type** list at the **Element Geometry** tab of the **Reinforcement** material dialog (only available in **ATENA Science** version 5.4.0 and higher).

For information about considering pre-stressing losses, please see 2.2.27.

See also 2.2.11 for general information related to defining reinforcement bond. If you observe unrealistic damage during the application of pre-stressing, see also 2.1.11.

2.2.6 How do I calculate the reinforcement ratio when defining smeared reinforcement?

The reinforcement ratio is simply the reinforcement cross section area divided by the total area of the section, A_r / A_c . Of course, this is calculated independently for each smeared reinforcement direction, always considering the corresponding section perpendicular to that direction.

For example, if you have a 20x20 cm square column with stirrups placed every 10cm (as in Fig. 2 -6), with cross section A_s each, the reinforcement ratio for both horizontal directions (assuming closed square stirrups = 2 legs in each direction) is calculated as

$$(2 A_s) / (0.2 \times 0.1),$$

i.e., area of the 2 bars divided by the corresponding concrete cross section area (column width times stirrup spacing). Alternatively, you may divide the total area of all bars ($2 A_s N_s$) by the whole column side area (0.2 times column length) and get the same ratio.

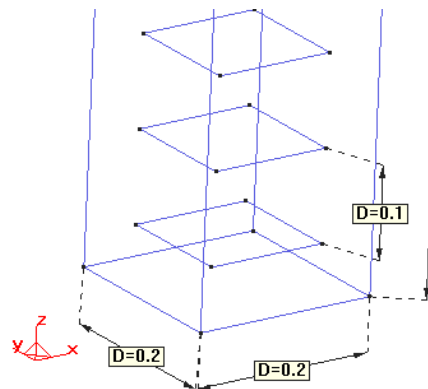

Fig. 2-6 Column with stirrups

2.2.6.1 Reinforcement layers in Shells

For shell elements, the cross section area of a smeared reinforcement layer is defined per 1m width, i.e., the unit is m^2/m . The width is meant perpendicular to the reinforcement direction.

Example:

You have a plate extending 3m in X direction (length), 2m in Y (width), 0.3m in Z (thickness) and wish to define the bottom reinforcement in X direction as a smeared reinforcement layer (Fig. 2-7). The bars have a cross section area A each, and are spaced 0.2m. That means per 1m of width, there are $1/0.2 = 5$ bars, and the cross section per 1m of shell width is $5A$.

Alternatively, you can divide the total number of bars (10) by the shell width (2m), and of course, you get the same 5bars/m or $5A/m$ cross section area.

If the cover is 4cm and the bar diameter 32mm, the layer distance from the bottom surface should be $0.04 + 0.032/2 = 0.056m$.

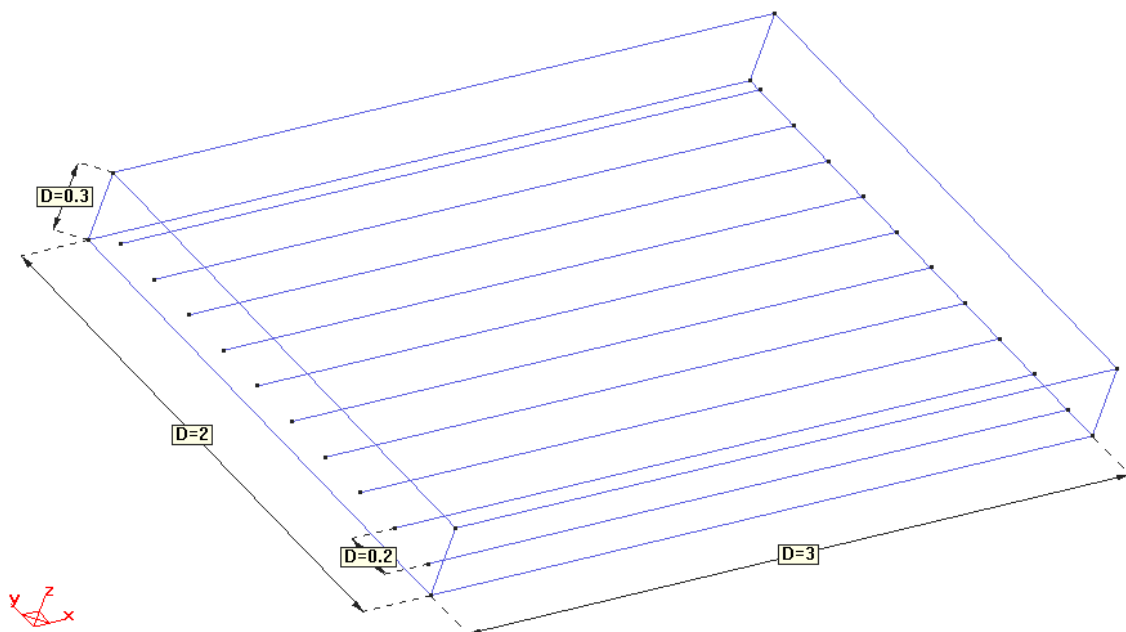

Fig. 2-7 Plate with bottom reinforcement

2.2.7 How to include confinement in the analysis?

The confinement effect (increase of the compressive failure stress due to compressive stresses in other directions) is being automatically considered in the material models SBETA, NonLinearCementitious2. A more detailed confinement sensitivity is implemented in the NonLinearCementitious3 material. See the multidimensional failure surfaces in the material models chapter of the ATENA Theory Manual [1] for details.

In short, there is no need to change the material parameters in the regions where confinement is expected (e.g., inside a reinforcement cage or similar). However, please do not forget a 2D plane stress model implies zero stress in the third direction, and therefore can not capture compressive stress building up in the 3rd direction and the induced confinement.

2.2.7.1 The influence of the volume change during crushing (*Beta*)

Confinement development can be significantly influenced by the **Multiplier for Plastic Flow *Beta***, where the default 0 means no volume change while crushing and is typically conservative. Negative values (compaction) are relatively rare, but positive values (expansion) up to 0.5-0.9 give the best results in many cases.

2.2.8 How can I include the influence of shrinkage?

To consider shrinkage in **ATENA**, there are 3 possible approaches (sorted from simplest to most complex):

1. reduce the concrete tensile strength (and/or fracture energy) to represent the part of the tensile capacity exhausted due to the reinforcement restraining the volume change.

In typical cases, the tensile strength should be reduced to 1/2 – 1/10 of the original f_t .

2. apply the shrinkage as initial strain (constant volume reduction throughout the whole structure/volume)

Typical values are between 150-450 microstrain (i.e., $-1.5e-4$ to $-4.5e-4$ relative deformation).

3. run a detailed analysis using the Creep analysis module

It is recommended to look at the Creep example from the **ATENA Science Example Manual** before starting this modelling approach.

If you observe unrealistic damage during shrinkage application, see 2.1.11.

2.2.9 How can I apply thermal loading?

Similarly to modeling shrinkage, it depends on the detail required for considering the temperature loading which **ATENA** program to choose. In **ATENA Science (GiD Preprocessor)**, you can define linear temperature gradients, or even run a Transport and/or Creep+Shrinkage analysis. See also section 4.1.1 if you are interested in temperature-dependent material properties.

In **ATENA Engineering**, temperature volume change can only be applied constant over each Macroelement.

2.2.10 How can I take the bending and/or shear contribution of reinforcement bars into account?

The 1-dimensional discrete reinforcement bar/cable elements (Fig. 2-8 b) in **ATENA** only have axial stiffness, i.e., no bending nor shear stiffness. The most exact way is using volume elements for the reinforcement, however, considering the minimum of 4-6 elements per bar diameter for reasonable bending response, this very quickly leads to too many finite elements, which makes the analysis unfeasible due to extreme memory and CPU time requirements. A possible exception are very small regions with a short segment of 1 or 2 bars, modelled as a hexagonal or even only square cross section.

2.2.10.1 Bending

Bending resistance could be captured at least roughly by modelling each bar by 2-4 bars of 1/2 resp. 1/4 the cross section area each, each positioned in the gravity centers of the corresponding 1/2 resp. 1/4 of the whole bar (Fig. 2-8 c, d).

Another option is to model the bar with a single shell element, square of the corresponding cross section area (Fig. 2-8 e) or 2 shell elements, forming together a hexagonal cross section (Fig. 2-8 f). This modeling can capture bending very well (depending on the number of shell internal integration layers), but only in the shell local Z direction. Therefore, it can be recommended for situations where the prevailing bending direction is known in advance.

2.2.10.2 Shear

To capture the shear response of a particular bar, using volume elements is frequently the only way. However, as typically only a short segment of the bar undergoes significant shear, it is usually possible to replace the rest of the bar with 1-D bar elements, and only model the part of interest using volume elements.

Smeared reinforcement

In some cases, the shear contribution of longitudinal bars can be relatively well represented by defining smeared reinforcement in direction perpendicular to the bars, with reinforcement ratio corresponding to the bar volume distributed evenly over the whole beam volume (see also 2.2.6).

Short 1D bars

In some situations, especially with bars crossing a contact, adding short diagonal bars crossing the contact can reasonably represent the dowel effect. If you know the direction, you can only include the tensile one of the 2 bars (or of 4 in 3D). If you are not 100% sure, put both, forming a cross.

Of course, this is an approximate modelling, intended to only qualitatively capture the response. Just set the bar parameters such that the bar volume (cross section area times length) roughly corresponds to the segment of the real bar in the contact region, i.e., bar cross section x its diameter as length (or the size of the surrounding concrete mesh) or similar.

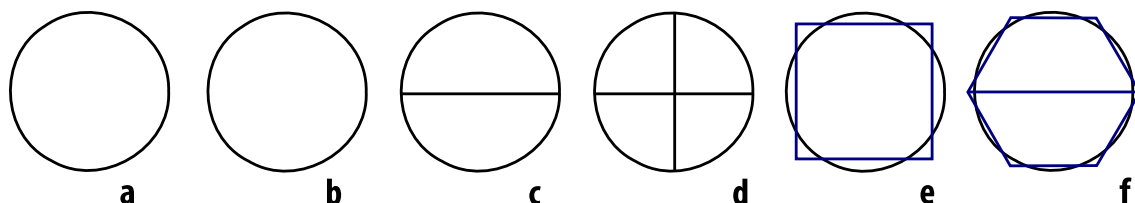

Fig. 2-8 Bar models (left to right, finite elements with full blue lines, original circle and its divisions black dotted): a) original circular cross section b) single discrete bar c) 2 bars d) 4 bars e) square shell f) hexagon from 2 shells

2.2.10.3 1D Beam as Reinforcement

In ATENA Science¹, it is also possible to use 1D Beam elements (with bending and shear stiffness) as embedded reinforcement. For more information, see ATENA-GiD User's Manual [16], 5.3.5.3 1D Reinforcement with bending and shear stiffness.

2.2.11 How can I take reinforcement bond into account?

By default, a perfect connection between the 1-D reinforcement bars and the surrounding volume elements is assumed in **ATENA**. In many cases, this captures well the real response, and no detailed bond modeling is needed, e.g., if the mesh is fine enough (comparable to bar diameter) and the bars are ribbed. For larger element and/or smooth bars, bond influence can be significant, and defining bond properties can make sense.

The reinforcement bond parameters can be generated according to Bigaj (1999) or following the CEB FIB Model Code 1990, or you can enter a user-defined strength-slip law. To do so in **ATENA Engineering** (2D, 3D), define a **Bond for Reinforcement** material, then select it in the reinforcement bar properties. In **ATENA-GiD**, select **BAR WITH BOND** for **Geom Type** on the **Element Geometry** tab of the **1D Reinforcement** material dialog and an additional tab **Bar With Bond** appears.

Please do not forget the bond law definition in **ATENA** is bond slip - bond strength, not bond slip - bond stress. In other words, no elastic bond slip is being considered explicitly in the ATENA bond model (it would kind of mean double-considering the elastic deformations of the neighbouring concrete elements in the analysis), i.e., the slip is zero until the bond strength is reached. This also means the bond function should NOT start with zero strength for zero slip (0, 0), which can make the system ill-conditioned, although we have had some examples like this in the database. If you are not sure, replace the 0 with at least about 10% of the maximum bond strength for zero slip.

2.2.12 How can I model a pull-out experiment?

There are two basic ways of modelling a bar or anchor being pulled out from concrete: 1. bar with bond, or 2. volume and interface elements. In both cases, symmetry can often be exploited to reduce the model size (1/2, 1/4).

2.2.12.1 Bar with bond

This approach is typically easier, however, please remember the discrete reinforcement elements have no bending nor shear stiffness (i.e., they only have axial response). Therefore, additional work is required if bending or shear response of the anchor bar plays a significant role (see section 2.2.10). See also 2.2.11 for general information related to defining reinforcement bond.

As applying load directly to a reinforcement point in the air is problematic, the following "trick" is recommend: add a small elastic cube or pyramid around the bar end, make sure there is **no slip** checked for that bar end, and apply the load force or displacement to a point of the elastic member. If you "wrap" the free bar end into a small elastic volume with Young modulus corresponding to steel (or even 2-20x

¹ Version 5.7.0 and later

higher), the deformations of the elastic volume are going to be negligible compared to other deformations.

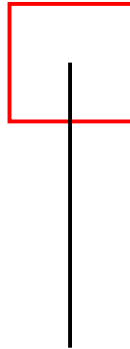

Fig. 2-9 Bar end wrapped in a cube

Please note you may need to fix lateral movements of the "wrap". If the pyramid/cube with the bar endpoint is allowed to move to the sides without any resistance (do not forget the 1-D bars only have axial stiffness), it is no problem in tension, but of course in compression (e.g., when simulating cyclic loading) when moving to the side has no resistance and compressing the bar has, it is clear what happens - the "wrap" moves sideways (without any resistance, which makes the system ill-conditioned). To prevent this unrealistic response, block/restrict the displacements of the "wrap" volume to the sides (i.e., perpendicular to the bar) by supports or springs.

2.2.12.2 Headed studs

The simplest way to model a headed anchor is to activate the **no slip** setting for the bar end with the head. If that is not precise enough, a combination of 1-D and volume elements can be used, see 2.2.12.5.

2.2.12.3 Unbonded segments

If bonding is prevented along some part of the bar (e.g., by a plastic tube around the bar), special attention is required. There are several possible solutions to prevent connection to a part of the concrete (and/or a steel plate or whatever):

a) divide the concrete into 2 parts, enforce mesh compatibility on the internal contact, and then edit the ATENA .inp file manually (see also 4.3.1) to only connect the bar to the bonded part of the concrete

or

b) make a (rectangular) hole in the concrete and/or plate (or, even better, replace the plate by 8 macroelements with mesh compatibility on the contacts to be able to use brick elements).

2.2.12.3.1 Notes on differences in bond properties along a reinforcement bar

Generally, different bond laws along a bar are not supported in ATENA. If you really need this, there is a possibility to define a multiplier function along the bar (the function will scale the bond law, i.e., multiply the max. stress value for each given slip), however, you need to edit the .inp file manually (see also 4.3.1) to do this.

If you have 2 bars with a common node, the displacements at that point will be continuous, however, the bond slips are independent (unless both have the **no slip at start/end** condition activated for that node, which forces both slips to zero).

2.2.12.3.2 Unrealistic bond stresses along unbonded segments

If you see unrealistic bond stresses (too high = too far from numerical zero) in bar segments "in the air" (between the concrete surface and the "wrap" at the end being pulled) or in segments separated from the concrete to prevent bonding, this is typically a consequence of the values being averaged from its endpoints (fixed to the concrete and steel). If the free/unbonded segment is long, the stress linearly decreasing from the end of bonding to 0 at the other end, this can give a contribution comparable to the bonded segment. To avoid or at least reduce this effect,

1. move the **no slip** endpoint to the surface of the elastic pyramid/cube. This gives 0 bond stress at the end of the free segment.
2. add a joint just next to the end of the bonded segment (e.g., 0.1mm away). This makes the solver iterate more (because that point is "hanging in the air", and if too far from the fixed, e.g., 1mm, the analysis does not converge), but it makes the bond stress along the major part of the free segment look more like zero.

2.2.12.4 Volume elements

Modelling the anchor with volume elements is potentially more precise than with a 1-D bar, but it typically leads to a model with much higher resource needs (CPU, memory), as a relatively fine mesh is required. This is not only due to the need of several elements per the bar thickness to be able to capture its bending response, but also because an opening has to be created in the concrete such that the steel (or another material of the anchor) does not overlap with the surrounding concrete (unlike the 1-dimensional bar modelling, where no opening is needed).

Moreover, it is not always straightforward to determine the properties of the Interface material to be applied at the steel-concrete contact (see also section 2.2.14). Significant parts of the contact area can usually be simplified as **perfect connection** or **no connection** in regions where it is clear in advance if there is compression or tension (e.g., **no connection** at the head bottom, **perfect connection** at the head top).

2.2.12.5 Combined approach

The two ways of modelling can sometimes be combined. A typical example is a headed stud where it is often efficient to represent the head with volume (or shell) elements, and use a 1-D bar for the shaft. Sometimes, it makes sense to use volume elements also for a part of the shaft near the head (where confinement develops).

2.2.13 *How can I model masonry?*

The traditional way of modelling walls, shear walls and similar structural parts build from masonry, i.e., from bricks (or stones) connected with mortar, is to determine some "bulk" material properties for the masonry, combining the bricks and the mortar. To verify and calibrate this "bulk masonry material" (typically represented with the NLCem2 material model, or, in 2D, SBETA), a small section of the masonry (e.g., 2x2 bricks) is modelled once in detail (bricks + interfaces representing the masonry

connections), and once with the bulk material (1 macroelement for each wall) under several loading types (tension, compression, horizontal shear at several levels of vertical compression, or similar). Then, the bulk material is used for the analysis of the whole structure.

For smaller structures, it may be possible to model all bricks discretely, i.e., represent each brick with a separate Macroelement or volume (or surface in case of 2D modelling), and each gap with an Interface. For the bricks, again, the NLCem2 or SBETA are the typical material models. In some cases (more likely with stones than bricks), it is enough to model the bricks/stones elastic.

Modeling the mortar with volume elements usually does not make sense (and is also not very feasible, because the very thin layer requires mesh refinement and results in a mesh with too many finite elements), maybe except for some special studies of just a small region between 2 bricks.

If you are interested in seismic assessment of masonry structures following the new Euro Code norm, you may also wish to check our software **AmQuake** [21].

2.2.14 I have problems when using the Interface (GAP) material on contacts

2.2.14.1 Check if Interface elements are really necessary

In many cases, the contact area (or at least a large part of it) can be simplified as **perfect connection** or **no connection** in regions where it is clear in advance if there is compression or tension (see also 2.2.12). If this possible, the work needed to define the Interface material parameters and the risk of related problems can be avoided completely.

2.2.14.2 Make sure the contact geometry is correct (GiD)

If you are using GiD to create your geometry, please see also the ATENA-GiD User's Manual [16], section *Interface Material* for instructions on defining the contact volumes/surfaces. It is very important that the two surfaces (or lines in 2D) to be connected are completely independent, i.e., that neither lines nor nodes are shared between them, and that their normals point in the required directions.

2.2.14.3 Define the Interface material parameters

The interface material settings with **tensile strength**, **cohesion**, and **friction** coefficient all zero are very likely to cause numerical problems. The friction coefficient is hardly ever lower than 0.1 (maybe except an oiled surface), if you have no better measurement/estimate, 0.3-0.5 are usually not far from reality. Cohesion always has to be greater than (or at least equal to) tensile strength times the friction coefficient, i.e., $c \geq ft \mu$.

If the interface **tensile strength** (ft) is higher or equal than the ft of the weaker of the materials being connected through it, it does not make much sense to model the interface at all. Then, a perfect connection can be used instead, because the concrete or rock or masonry or whatever) next to the interface cracks under the same load as the interface (or lower)!

If there is no info about the interface properties and it is only known/expected the interface should separate before the concrete (or other material) next to it cracks, it is

recommended to set the Interface f_t to 1/2 or 1/4 of the tensile strength of the weaker material next to the interface. The Interface cohesion C is recommended to be set to 1-2 times the Interface f_t (cases, where C smaller than f_t , are very rare).

A good starting value for both **initial stiffnesses** is about 10 times the stiffness of the adjacent finite elements, i.e.,

$$E_{\text{concrete}} / \text{elem_size} * 10$$

For example: $30\,000 \text{ MPa} / 0.1 \text{ m} * 10 = 3\,000\,000 \text{ MN/m}^3$ for K_{nn} and K_{tt} .

The **residual stiffness** values for numerical purposes are recommended about 1/100 - 1/1000 of the initial values.

See Section 4.4.3.2 Interface material in ATENA 2D User's Manual [2] and 2.6 Interface Material Model in the Theory Manual [1], especially the paragraphs following Fig. 2-38.

Background note:

In general, the lower reasonable limit for the interface material **stiffness** is about the stiffness of the less stiff neighbouring elements, i.e., $E_{\text{concrete}}/\text{elem_size}$. The upper limit is about 1000 times the stiffness of the stiffer neighbouring elements, i.e., $E_{\text{concrete}}/\text{elem_size}*1000$. Of course, if the element sizes on the 2 sides of the contact differ significantly, the stiffer material is not necessarily the one with stiffer finite elements (e.g., if there are large elements in steel and small elements in concrete, the small concrete elements can be stiffer compared to the large steel ones).

Under the lower limit, the elastic deformations of the contact (above all in compression) are larger than the elastic deformations of the adjacent layer of elements, which leads not only to visual overlaps of the volumes in contact, but can also unrealistically postpone nonlinearities (plasticizations, cracking, etc.) in other parts of the model, as the deformations may concentrate in the elastic interface displacements without producing any damage.

Exceeding the upper limit means large differences in the stiffness matrix, which is not good for the numerics - a too high condition number may completely break down the linear solver and result in convergence problems or wrong results.

2.2.15 How to model a load combination, e.g., a constant vertical force during horizontal displacement applied until failure?

Loads are incremental in ATENA. In other words, unless you unload (by applying a negative force, or, to be precise, force of the same size with the opposite sign), the load stays there. In this case, it means you apply the vertical load divided in 5-10 load steps and then apply the horizontal displacements in the following steps. Do not forget to apply the supports in all load steps.

See also 2.4.6.1 for recommendations about solution methods. If you are interested in cyclic loading, see 3.1.1.

2.2.16 How can I model a compression-only support with nonlinear springs?

For nonlinear springs, it is generally recommend to define the inactive side of the working diagram as 1/100-1/1000 of the stiffness in the active direction. For example, if the compressive side of a "compression-only" spring is (-1, -5000), you should define the tensile side (1, 50) or (1, 5), see Fig. 2 -10. Pay good attention to the spring direction, as it also determines which direction corresponds to tension and which to compression.

If you have problems with springs in ATENA Engineering 3D, please see also 3.4.4.

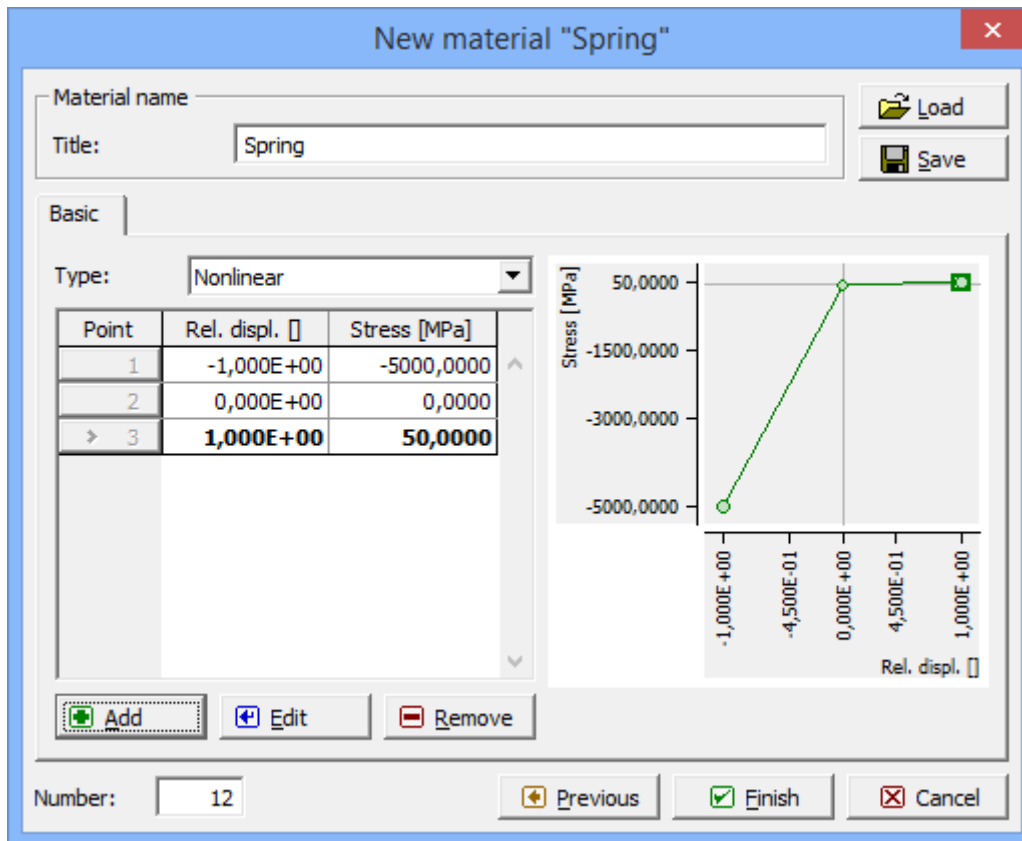

Fig. 2-10 Example of nonlinear spring material

2.2.17 The analysis runs too long. How can I speed it up?

To reduce the analysis running time, using efficient modelling can make a substantial difference. This includes

1. making use of symmetry (1/2, 1/4, 1/8, axial, or even 2D model, if both the geometry and boundary conditions are symmetrical),
2. avoiding unnecessary edges, e.g., modelling small round members or openings as rectangular or max. 6- or 8-sided (with the same cross section; other small complicated profiles can also be replaced in a similar way) or replacing unimportant bars with smeared reinforcement.
3. more effective meshing, like only refining where needed and separately for each direction. For example in bending regions, multiple volume elements per thickness are

needed, but the elements can be larger in the other directions (as long as the edge aspect ratio does not exceed 3-4:1).

4. Other things which also slow down the analysis significantly are material laws with wrong parameters, like zero tensile strength of concrete, or just more complicated than necessary. A typical example is interface (GAP) which can be frequently replaced by **Perfect connection** or **No connection** in areas known as compressive/tensile in advance (see also 2.2.14).

5. We generally recommend to store the results for every 5th or 10th all analysis step (+maybe some important steps corresponding to an exact load level which is to be post-processed), which can save a lot of disk space and also time spent writing the file(s) during the analysis compared to saving the results from all load steps.

See also the tips in sections 2.4.1 Out of memory error during ATENA analysis and 2.1.6 I plan to buy a new PC to run ATENA on it, what do you recommend? **AtenaConsole** has the lowest overhead during the analysis – you can consider using it instead of **ATENA Engineering 3D** or **2D** or **AtenaWin** (see section 4.3.1 on instructions how to run **AtenaConsole**).

2.2.18 My analysis results do not match the experiment/expectations. How can I improve my model?

We recommend to first of all look at the Load-Displacement graph (the best way is to put the measurement and analysis values into one graph). Make sure to match the initial stiffness (the initial slope of the L-D graph). If it does not, check the boundary conditions (supports, loads, symmetry planes, etc.), the E-modulus, and reinforcement area & modulus to get there if necessary. Check the mesh, for example if bending regions have enough elements per thickness (at least 4 for qualitative only-results, min. 6-10 for quantitative results; alternatively, use shells).

After the initial stiffness is OK, look when and where cracking and reinforcement yielding (and eventually, other nonlinearities) develop, and then check and, as needed, adjust the corresponding material settings, mesh, or geometry.

A relatively common source of differences is neglecting shrinkage – see 2.2.8 for advice how to include it.

2.2.19 How can I monitor a surface (or line) load?

In **ATENA-GiD**, you can utilize the **Summation** option of **MaxMonitor**, e.g., to monitor the reaction at a surface with prescribed displacement, use **Data | Conditions | MaxMonitor for Surface | Reactions | Summation**.

In **ATENA Engineering**, you need to output the forces/reactions at the line or surface (see also 2.2.21), and sum them outside of ATENA, e.g., in a spreadsheet.

Sometimes, it is possible to replace the load/support with one or a few point loads/supports (see 2.2.19.1), and record the load by monitoring the reaction in a single point (or sum the reactions from 2 or just a few point supports).

If not, you can either monitor the load in a point, find the scale factor in the first step, and multiply the value for the graph by this multiplier to see the total force. Or, you may use a trick - add a small (e.g., 1/1000) point force into another node (maybe even in

another direction) and monitor that external force. Then, you know the multiplier from the beginning.

2.2.19.1 Recommended alternative: Point load and an elastic loading plate

In general, to make monitoring the reactions or loads easier, we recommend to use point load/support instead of line/surface, applied through an elastic loading/support plate (do not forget a point load or support applied directly into nonlinear material can lead to unrealistic local damage – cracks, plasticizations, etc.). Young modulus corresponding to steel or 2-20x higher is recommended for loading plates.

Although there are some situations, e.g., water pressure or distributed load on a larger area, when a surface load can not be avoided, this replacement is possible in most cases.

2.2.20 How can I see the numerical values of monitors and export them into a spreadsheet?

In **ATENA Engineering 3D**, you can display the values using the **File | Print text ...** command (and copy-paste into a .txt file or spreadsheet).

In **ATENA Engineering 2D**, the command is **File | Text printout ...**

In **ATENA Studio**, you can copy the graph to clipboard and later when pasting it into some other program, decide if it should be inserted as picture or as numbers, see also **ATENA Studio User's Manual** [15], 4.5 Diagram Window.

If you run the analysis in **ATENA Studio** or **AtenaConsole** and the option **Write Monitor Data** in **Problem Data – Global Options** is not disabled in **GiD**, the monitors are written into a file named **monitors.csv**. The file can be directly imported into a spreadsheet and is updated after finishing each load step.

In **ATENA Science**, you can also use **AtenaWin** [14] or **ATENA Studio** [15] for text output (we do not know about a way to export text results from **GiD Post**). Open the **Output | Data Request** dialog, select **OUTPUT_DATA** for **at location:**, then look for **MONITOR_SET_** in the list (you can also use the **Filter** option to make the search easier) and select the monitor you need. By pressing **Apply** the values are written to the .out window (you can either Copy-Paste from there or store the buffer to disk; the command from the **Output Command** tab can be used in an input file (see also [13]) to output the values during an analysis or for batch processing results with **AtenaWin** or **AtenaConsole**). We recommend making sure the .out window is not hidden before opening the Data Request dialog to be able to immediately see the output.

A few notes to importing the text results from **ATENA** into a spreadsheet:

1. **ATENA** always uses the decimal point, regardless of the OS locale settings. If your OS is set to decimal comma, you may need to set "dot" in the import settings in the software you are importing into, or just do "Find & Replace" dot for comma before importing the file.
2. Please choose "fixed length" instead of "tab/space/comma/semicolon separated" if the columns are not recognized correctly. Then you have set the column positions manually.
3. If you are writing to the .out directly after the analysis is finished (and not after reading the last step results by the **Restore FE Model from** function), I would

recommend to only copy the lines with the monitors from the end of the .out file into another file (instead of importing the whole .out file).

2.2.21 How to get the nodal forces at 100 nodes as output in text-file or other?

In **ATENA Engineering 3D**, use the **File | Print text** command. In **ATENA Engineering 2D**, the command is **File | Text printout**. Select the step you are interested in, then **Nodes**, then the quantity, e.g., **Stress, Strain, Reference Nodal Coordinates** (= original positions of the nodes, i.e., undeformed structure), **Current Nodal Coordinates** (= positions of the nodes on deformed structure).

In **AtenaWin** or **ATENA Studio**, use the **Output | Data Request** dialog. Select **Nodes** for location, and then select the attribute name of interest.

2.2.22 How to detect a structural collapse or ultimate load capacity

In most ATENA analysis, the main goal is to determine at which load level the structure will collapse, i.e. what is the ultimate load carrying capacity.

To obtain this answer the model should follow the two basic rules:

- (1) the load should be gradually increased/applied up to failure
- (2) the model should include at least two monitors: one for monitoring the applied loads/forces and one for monitoring the maximal deformations.

It should be understood, that as the load increases, the failure occurs, and the structure cannot sustain the applied load. If the load is constant or increasing, the convergence cannot be reached. This means that the structural collapse will exhibit itself as a failure to reach convergence (see also 2.1.19 and 2.4.2). But our monitor for the loads will be still increasing as well as the monitor for deformations. The monitor for deformations will be however increasing much faster so in addition to the convergence problems one can also observe a sudden change in the slope of the load-displacement diagram. This approach is however, not very reliable since the convergence problems as well as the change in the load-displacement diagram can have other reasons. The convergence problems could result from using two large analysis steps or by numerical problems in the nonlinear solution. The change of the load-displacement slope can be a result of crack development or other nonlinear effects.

For the accurate detection of structural collapse, it is therefore recommended to use Arc-Length option in ATENA solution parameters. This method starts automatically reducing the applied loads to capture the peak in the ultimate capacity.

The standard loading process could be for instance to use the standard Newton-Raphson method for load steps up to the level of the design load. Then the solution method should be switched to Arc-Length, and new step interval should be defined with the appropriate loads. These will be gradually applied until failure is detected, when the Arc-Length solution will start automatically reducing their level to trace the post-peak response.

2.2.23 How to continue (restart) the analysis from a calculated step?

If you change the load step definitions or solution parameters in the middle of the analysis, you do not need to restart the analysis from the beginning (and calculate again also all the steps without any changes).

2.2.23.1 ATENA Engineering

In **ATENA Engineering** (both 2D and 3D), the GUE automatically recognizes which steps need to be (re-)calculate after the modifications.

2.2.23.2 ATENA Science – when running from the ATENA-GiD Interface

The **ATENA-GiD** Interface also supports continuing the analysis from a previously stored step. For more information, please see the **ATENA-GiD User's Manual** [16], 5.5 Problem Data, especially Fig. 5-90 Restart calculation options in problem data dialog.

2.2.23.3 ATENA Science – when starting the analysis manually

If you are starting the analysis manually (e.g., in **ATENA Studio** or **AtenaConsole**, see also 4.3.1), you need to edit the ATENA Input File (.inp) manually. If you are running an Input File originally created from the **ATENA-GiD** Interface, there are predefined labels and commands for this purpose, see the **ATENA Studio User's Manual** [15], 3.4 Calculation Control.

Please understand the .inp files written from **ATENA 3D** (or created by other means) do not contain the pre-defined labels and commands for restoring the analysis, and therefore, more editing work is needed. Basically, you make a copy of the .inp file, delete everything before the "STORE TO" command corresponding to the stored step, and change it to "RESTORE FROM", and then run the analysis for the modified .inp file.

2.2.24 ATENA only offers translational supports. How to specify conditions for "hinge support" (rotations) or block all rotations at the end of a column?

You can choose surface, line and point supports to block the translational displacements and rotations as needed. A single point support does not block any rotation, a surface support only in one direction perpendicular to the surface allows a rotation around the surface normal, etc (in **ATENA Science (GiD Preprocessor)** you can also define special Master-Slave connections to only bind 1 or 2 DoFs of 2 points or lines or surfaces).

For example, to a horizontal surface, you can apply a surface support in Z, and only block the displacements in X and Y in a single point (center) = only the rotation around the vertical axis remains unblocked.

Another frequent example: in case of column buckling with both ends fully fixed, if you know the weakest=buckling plane in advance, you can usually take advantage of symmetry according to that plane, which excludes 2 rotations. To exclude the remaining one, you can for example apply the prescribed displacement in 2 points of the loading plate instead of only one (and then sum the reactions).

2.2.25 How can I import the geometry from my CAD / the model from my other FEM?

With respect to imports, we recommend trying to find a well working file format common to **GiD** and your other CAD or FEM. **GiD** can import the geometry from many formats.

However, our experience so far with imported geometries is that typically, there are changes required to be able to reasonably mesh, which at the end leads to importing points and most lines, possibly also some surfaces, and re-doing most of the volumes and some surfaces. Also re-assigning all materials and boundary conditions after each import makes it typically faster to do the changes in **GiD** compared to importing another similar model.

In other words, in most cases the most efficient way is to build the geometry in the modeller (**ATENA Engineering** or **GiD**) from scratch anyway. For simple geometries, the time spent fixing the volumes, etc. definitely exceeds the time to create the model specifically for FEM from the beginning. If the geometry is more complicated, it can make sense to use imported joints instead of re-typing or copy-pasting their coordinates.

If you expect the need to use geometry from your CAD or FEM frequently, you may also look at the IXT import in **ATENA Engineering 3D** - maybe you can write some utility/script to get the node coordinates (and possibly somewhat more) into this simple format.

2.2.26 How can I model cyclic or fatigue loading?

There are 3 basic approaches to consider the effects of cyclic loading in ATENA:

1. (suitable for low-cycle loading): calculate the cycles explicitly, use the cyclic reinforcement material (Bauschinger/Menegotto-Pinto) and set the parameter Unloading for concrete (NLCem2 material model). If needed/applicable, you can also use the cyclic reinforcement bond material (Memory Bond - enable and set τ_1). See the manuals for more details about the mentioned material models and options.

It may be also needed to consider the dowel effect contribution of longitudinal reinforcement, see 2.2.10. You may also wish to see 3.1.1 for basic ideas related to defining cyclic loading.

Of course, this approach works fine for tens of cycles, and hundreds or even low thousands are possible, but clearly, explicit modelling is no way for millions of cycles.

2. (the classical approach and the only way for high-cycle fatigue with ATENA Engineering): only calculate the 1st load cycle (or just its loading part), look at the stress ranges (or strain ranges when using a strain-based criteria) between the cycle bottom and top (or export them) and evaluate the S-N (Wöhler) in a spreadsheet (or by hand) for the critical point(s)/region(s).

3. (only available through the ATENA-GiD interface of ATENA Science):

Use the NLCem2Fatigue material model for tensile fatigue of concrete. This is suitable even for millions of cycles, but a few explicit unloading-reloading cycles are typically needed for capturing redistribution effects. Please also do not forget only tensile fatigue of concrete is being considered.

For more information, please see the ATENA-GiD User's Manual [16], 5.3.1.3 CC3DNonLinCementitious2Fatigue and 5.4.1 Fatigue, and ATENA Theory [1], 2.2.10 Fatigue.

2.2.27 How can I model pre-stressing losses?

There are many sources of losses when pre-stressing or post-tensioning is applied. In **ATENA**, there are 2 basic ways to take pre-stressing or post-tensioning into account: by applying **Initial Strain** (this includes the **Prestressing** load case applied to **Reinforcement bars** in **ATENA Engineering**, where the stress or force is automatically converted to strain based on the elastic modulus) and by applying the condition **Prestressing for Reinf Line** (available in **ATENA Science** and only for cables; see also 2.2.5 for basic information about modeling cables (especially injected cables, i.e., post-tensioned, then bonded); the **Prestressing** load case applied to **External cables** in **ATENA Engineering** works this way, too, although with some limitations, above all, the arrow marking the **Active anchor** can be displayed wrongly).

1. Losses due to the (elastic or possibly also plastic/cracking) deformation of the surrounding concrete are automatically considered.
2. Losses due to shrinkage or/and creep can be considered in various ways from simple to detailed. Simply said, they are automatically considered as soon as the deformation of the concrete due to the creep/shrinkage is represented - see 2.2.8 for the options available for that.
3. Losses due to channel friction and curvature are typically only of interest for cables (unbonded or post-tensioned and then bonded) and can only be considered using the condition **Prestressing for Reinf Line** (see the tab **Cable** in the **Reinforcement** material dialog).
4. For losses due to anchor slip, the most frequent way of modelling is reducing the applied pre-stressing value.
5. It is also possible to calculate the losses outside of **ATENA** and apply the resulting strains through a function along the bar or cable (see the option **Definition by function** in the dialog for the condition **Initial Strain for Reinf Line**; only available in **ATENA Science**).

2.3 Older issues

This section could be called an archive of general problems believed to be solved in the current **ATENA** version.

2.3.1 Problems in Windows Vista

When installing in Windows Vista, make sure to enable the "Run as administrator" option before starting the installation if you encounter problems during the installation or when starting the installed program.

In **ATENA** version 4 (and later), the installer request the right escalation through UAC automatically.

2.3.2 Principal strains in 3D material models may show wrong values in the post-processor

The shear terms are not divided by 2 in the calculation of principal values. This affects only the output values. In the calculation of 3D material models, the principal strains are calculated correctly. Problem fixed in version 1.1.2

2.3.3 Principal stresses in 2D material models may show wrong values in the post-processor

This does not affect the calculation, but only the output of results. Problem fixed in version 1.1.2

2.3.4 Problem with some very old parallel hardlocks in ATENA 3.3.0

Some very old parallel hardlocks (pre-2000, originally supplied with SBETA) do not work properly in ATENA 3.3.0. If you experience crashes while generating the FE mesh or starting the analysis, ask for a new HW key, you can choose parallel or USB.

See 2.4.12 for problems with newer hardware keys.

2.3.5 Return algorithm of the plasticity model has changed in version 3.3.0

The return algorithm of the plasticity model has changed in version 3.3.0 (06/09/14). The BETA parameter of the NonLinCementitious2 model now has a different impact on the final results. Specifically, if a standard Poisson's ratio of 0.2 is used, the BETA parameter of the new solver is equal to half of the BETA parameter of the old solver. Hence, all old models with nonzero BETA should be updated.

2.3.6 CC3DNonLinCementitious3User material changed in version 3.2.5

The CC3DNonLinCementitious3User material is slightly modified starting from version 3.2.5. The unloading in tension is elastic up to the onset of localization. After the localization onset the unloading is to the point where the localization started.

2.3.7 CC3DCementitious material and CC3DNonLinCementitious materials may show stronger behaviour in version 2.0.1

The CC3DCementitious material and CC3DNonLinCementitious materials may show stronger behaviour in version 2.0.1 than in previous versions. The failure envelope has been modified to better represent the tri-axial compressive behaviour of concrete. This difference should be significant only in stress states with high confinement. In previous version of ATENA, this tri-axial strength was highly underestimated.

2.3.8 Fatigue analysis gives different result since version 5.1.3 or 5.3.1a

In version 5.1.3/5.3.1a, the fatigue material model has been changed and improved compared to previous versions (i.e., up to 5.1.2e and 5.3.1). You may need to adjust the parameters **BETA_FATIGUE** and **KSI_FATIGUE** to reproduce old results.

2.4 ATENA Kernel Messages and Problems

Error and Warning Messages reported by the ATENA kernel.

2.4.1 Out of memory error during ATENA analysis

First of all it has to be made clear that the "Out of memory" message refers to RAM, not disk space. There are many factors deciding about how close to the 2GB limit (or 3GB in case of 64bit systems) a 32bit program can get - not only the physical memory available, but also other SW running, the graphics board (the video or disk controllers/drivers can occupy a large portion of the address space, and divide it to smaller fragments), etc.

If you can not make your model smaller (e.g., by making use of symmetry or a coarser mesh etc., see also section 2.2.17 The analysis runs too long), you can switch from the standard direct band matrix solver (LU) to one of the sparse iterative solvers (ICCG or DCG), which have considerably lower memory requirements. See section "3.7.1.1 Analysis information" in the ATENA 3D Users Manual [3] for details.

Another way is to run the analysis in **AtenaConsole** instead of **ATENA 3D** or **AtenaWin**. Since version 4.3.0, there are also 64bit variants of **AtenaConsole**, **AtenaWin**, and **ATENA Studio** (since 5.0.0) included in installation - then, only the physical memory size is the limit. See section 4.3.1 on instructions how to run **AtenaConsole**.

2.4.2 I get the message "The execution is killed due to violation of stop iteration criteria", what does it mean?

If you get the message "The execution is killed due to violation of stop iteration criteria" or "The execution is killed due to violation of stop step criteria" and you do not understand what it means, please read about the **Conditional Break Criteria** in section 3.7.5.1 Solution parameters of the ATENA 3D User's Manual [3]. See section 2.1.19 for more information about the convergence criteria.

Basically, these options are designed to stop the analysis when the convergence errors (see 2.1.19) at the end of a load step or iteration are so large, that continuing the analysis does not make sense with respect to results quality. However, please understand the default settings are not necessarily the best for all problems. The values can be modified by the user. See also 2.2.22 for more information on detecting structural collapse.

However, please note that if the analysis breaks earlier than expected, in most cases, there is some other problem than the stop criteria setting - see 2.4.6 for recommendations how to improve convergence and find sources of numerical problems.

2.4.2.1 Recommended settings

With the default convergence error tolerances of 1% for the first three criteria (i.e., all except for the energy), setting the corresponding Step Stop Multipliers to 10 (or 1000 for the energy) can be recommended in many cases (it means the analysis breaks if the convergence error at the end of a step exceeds 10%).

2.4.3 I get the message "**Warning: Node NNN dof D has probably excessive value XXX.XXX used in element id: EEE, group id: GGG, name: ...**"

The deformation (or temperature) of the listed node is unusually high (the number identifying the degree of freedom (DoF) identifies the direction – DoFs 1, 2, 3 correspond to the global X, Y, Z directions in most cases, except for shells, where the local coordinate system is used). In most cases, this is a result of some problem in the model (see 2.4.6 for suggestions what to check) or structural failure.

2.4.4 I get the warning "**Invalid master-slave**" during analysis, what is wrong?

This warning says that there are multiple boundary conditions (constraints) assigned to a node (nodes), or some Slave nodes could not be connected to any Masters. This is in most cases NOT an error since only one is applied, while others are ignored, or only part of a partial contact surface gets connected. However, a warning message is reported, since the program does not know if it was really an intention and the situation may be a consequence of wrongly assigned BCs.

In a typical case, this message occurs in regions where master-slave conditions meet other boundary conditions (like prescribed displacements), e.g., on a boundary line with displacement constraint, which has its end node connected to the neighbouring macroelement (i.e., it belongs to the surface in contact with the other macroelement).

ATENA usually creates double nodes at macroelement boundaries, one node for each macroelement. In this way, each macroelement has its unique entities, which makes the operations with data of macroelements easy, such as adding, deleting, etc. In the solution core, nodes with identical locations, which are kinematically connected, are processed by Dirichlet BC procedure, which puts all prescribed constraints in each degree of freedom (DoF) together and issues the warning if there is more than one.

Do not worry about this message, although it always makes sense to check the locations of the reported nodes if there is any problem with the model.

2.4.4.1 Connecting quadratic and linear elements

If you mix quadratic elements (e.g., shells) with linear in a model (in **GiD**, this means enabling the **Non-Quadratic Element** option for some material at the **Geometry** tab), please note the general recommendation "the side with the larger elements is to be the Master" relates to the element node distances, and the quadratic elements have additional nodes in mid-edges compared to linear ("Non-Quadratic") elements of the same size. The two basic solutions are:

A. Make sure the quadratic (e.g., shell) elements are at least the double size of the [linear] volume elements in the neighbouring concrete and make the quadratic surfaces

Master,
or

B. make the quadratic side Slave and ensure the surrounding linear elements are larger than 1/2 of the shell edges.

2.4.5 During calculation I get the warning: "Redundant (needless) LHS BCs detected for the following u (node_id, do_id): they will be ignored." or "Warning: Attempt to constrain slave/use master non-active or zero dof: ... constraint ignored."

The message (often repeated for multiple degrees of freedom):

Redundant (needless) LHS BCs detected for the following u (node_id,do_id): they will be ignored. (Source line: 1015, file: ...)

or

Warning: Attempt to constrain slave/use master non-active or zero dof: DoF_id of node: node_id, load case: lc_id, dof BC: cond_id, LHS BC id: lhs_bc_id; constraint ignored.

is a result of applying supports in a direction to nodes that are already held in that direction by other means. Typically, this occurs at supports applied to macroelements connected through master-slave connections (e.g., 2 blocks next to each other, supported from bottom), or when shells are supported in a direction not perpendicular to their thickness (then, the implicit master-slave in depth direction and the support act in the same direction).

A boundary conditions' conflict can also occur on a line (point) shared by 2 surfaces (lines) with boundary conditions applied. In that situation, you may need to apply the combined condition explicitly to the line (point), if the 2 conditions are not identical (see also 2.1.12 Strange deformations in a corner or on an edge).

2.4.6 Floating point problems - Division by zero, Loss of >7 digits on the matrix diagonal, CCFEModelExc: CCPardiso solver error: zero pivot, Warning: Sign of diagonal changed when reducing equation, Floating point exception: Multiple floating points traps, Zero or negative jacobian, InvertA: zero determinant, CCMaterials Extended AExc: CC5ParamYield F: project_stress_on_f_division by zero, and similar

First of all, look at the model in a step before the message occurs. Investigate anything unusual - is there a support missing? Is the load the intended (i.e., are you not accidentally applying, e.g., 10MN instead of 10kN or similar)? Isn't a point load or support applied directly into nonlinear material (see also 2.2.19.1)? Are there cracks in unexpected regions, a strange deformed shape, ...? Check the convergence (see also 2.4.2). Typical problem sources are badly supported or wrongly connected structure (mechanism), an element of [numerically] zero volume (please check the mesh), problematic material settings (e.g., interface properties, wrong magnitude of elastic modulus, ...), or similar. If you are using temperature-dependent material properties,

please also check section 4.1.1. If you use contact elements (GAP, interfaces), please also check section 2.2.14.

2.4.6.1 Solution methods

Please note that in case of force loading up to failure (or further), you need to use the **Arc Length** solution method (AL). In all other situations, i.e., displacement control (pre- or post-peak) or nominal force loading (dead weight, 100% service load, etc.), use **Newton-Raphson** (N-R). The typical procedure is to load with N-R up to some nominal load level (100%), then continue overloading with AL. Do not forget AL can scale the load increment applied in each step, which makes monitoring even more important. See ATENA Theory for details and background information.

2.4.6.2 Equation solvers

When the default PARDISO linear equation system solver, or one from the sparse iterative family (ICCG, DCG, ...) cannot give any solution, it frequently helps to switch to the slower, more memory intensive, but more robust LU ("standard") solver. Usually, the problem source (e.g., missing support or contact) can then be identified by a look at the deformed shape. After correcting the model, you can switch back to one of the faster solvers.

If you can not find the cause, please send us the model along with your ATENA User ID (WR) as instructed in 2.1.1.

2.4.7 I get the warning "Convergence criteria (within line search) not satisfied due to eta limit, continuing super-ordinate iteration" during analysis, what does it mean?

It is a warning about the line search iterations. The **Line search** method is explained in the Theory Manual [1] in chapter 4.5 Line Search Method. This method only helps to stabilize the convergence process. Normally, the solution parameters are defined such that only 1-2 line search iterations are performed in each step. Thus, it is quite normal that it is not enough for this method to fully converge, but it is not a problem and the main important thing is that at the end each analysis step converges (see also 2.4.2). This you can for instance check in the menu **Data | Analysis progress information** in **ATENA 3D**.

2.4.8 I have this error: CCINPExc: Illegal real number 0, line N, file ..., data being processed

Most likely, you have set to zero some material parameter that has to be positive (or vice versa), e.g., 0 elastic modulus or aggregate size. If you are not sure which one, the fastest way to find out is to store the .inp file (**Data | Save INP files | Together** in **ATENA 3D**) and look at the mentioned line N.

2.4.9 CCInpFExc: Syntax error reading ATENA input, line: N, file: ...

If the analysis stops at the beginning with an error like

CCInpFExc: Syntax error reading ATENA input, line: 103, file: C:\AtenaModels\MyModel2.gid\AtenaCalculation\MyModel2.inp, data being processed:

1.818000e-02

Please open the Input File (.inp) and look at the line referred in the message (in the above example, 103). Most likely, you will find there the definition of some function used for the reinforcement, e.g.,

```
xvalues 0.000E+00 1.808110e-02 1.800000e-02 1.818000e-02
```

Please remember the values on the horizontal axis (x) have to be sorted from lowest to highest. In this particular case, the strain at yield 1.808110e-02 is greater than rupture strain 1.800000e-02 (which is an obvious nonsense).

The most probable way this happened: you have entered your function points in unsorted order. Or, you have changed the elastic part (E, yield) and not updated the following points accordingly. In any case, please correct the function definition in the corresponding GiD dialog.

If the line does not belong to a function definition, please check if the line generally makes sense (see also 2.4.8).

2.4.10 *CCMaterialExtendedAExc: FC0 greater then FC in material (material X)*

The stress level when nonlinear (plastic) deformations start to develop is set higher than the compressive strength. This typically happens if you significantly modify the generated material parameters for concrete. The recommended procedure is to generate the material model for the closest concrete class or cube strength, and only do minor adjustments to values you have measured or received from the manufacturer.

If you decide to change the values, it is your responsibility to make sure the resulting set is consistent. See the Theory Manual [1] for details about the material models. In general, it is recommended not to change any of the generated values unless you have a measurement or at least a good estimate.

2.4.11 *I get a message that I can't understand: Shell/plate macroelement X contains more then a single layer of elements in the direction of the local Z axis.*

Stacking shells in thickness direction does not make much sense (at least in a vast majority of cases). As explained in the User's Manuals ([3], [16]), a single shell element is enough even for bending regions (unlike volume elements). To improve precision, increase the number of the internal shell layers instead.

2.4.12 *Hardware key not recognized (HASP – required key not found, invalid user id check, ATENA only running in Demo mode, or similar)*

First of all, make sure the hardware key is correctly connected to a local USB port or through the network (see also 2.4.13 Problem with Network Key; note the **Sentinel Admin Control Center** now supports both network and local USB keys, and a firewall can block even communication with a local USB key), and the drivers are installed (you may wish to download the latest drivers from our web [19] or directly from

<http://www.safenet-inc.com/>). Check if the key is not physically damaged and its light goes on when connected.

If this does not solve the problem, the most common situations are described below. If you have problems with the GiD license (USB, computer-bound, or network), please see 4.2.4 Problems with GiD license, USB or network floating.

In any case, we recommend to ask your local system administrator for help.

2.4.12.1 After upgrading from ATENA 4.3.1 (or older) to ATENA v5

Please see 2.4.14.2.

2.4.12.2 After updating from ATENA 5.0.0 (or later) to the current ATENA v5

If you have downloaded the latest installer, please make sure your maintenance has not expired before the release date of the version. If so, please contact your ATENA distributor for an extension offer, or (re)install the latest version released within your maintenance period.

You can use the **ATENA Update Check** utility to verify the dates. If you have recently prolonged or renewed your maintenance, make sure you have already applied the extension to your HASP key (see 2.4.14.2).

2.4.12.3 When using a network key (network floating licenses)

Please see 2.4.13.

2.4.12.4 When running ATENA remotely through Terminal Services

To run **ATENA** installed on a terminal server using a Terminal Services connection, a Network Key (NetHASP) is required. The Net Key can be attached to a USB port of the terminal server or to another computer on the local network, but in both cases, the HASP drivers and the **License Manager** have to be properly installed on the computer where the key is attached.

2.4.13 Problem with Network Key

Symptoms: when **ATENA** is started, sometimes there are error messages complaining about the HW key, although the server with the **NetHasp License Manager** and connected Network Key is accessible through the local network (see also section 2.8 of the ATENA Readme file).

Reason 1a: another network key is found first

Reason 1b: the network key is on a different subnet and therefore can not be found with the default search settings

Solution 1/ATENA 5.0.2 and later: Direct the remote key search to your Licence Manager server. The HASP configuration file is now stored in **%CommonProgramFiles%\Aladdin Shared\HASP\hasplm.ini** (e.g., C:\Program Files (x86)\Common Files\Aladdin Shared\HASP\hasplm.ini), and the file format is also different from the old NetHASP.ini. The configuration can be created in the **Sentinel Admin Control Center**, which is typically available at <http://localhost:1947/>. The network related settings can be found under **Configuration | Access to Remote**

License Managers. Typically, it is enough to just paste the license server IP address (text or numeric) to the largest textbox on that page (i.e., the address will be the only text in the box). Please do not forget that Administrator rights are typically required to save the configuration into Program Files (the full pathname of the configuration file displayed at the bottom of the configuration page).

Sample NetHasp configuration file *hasplm.ini*:

```
[REMOTE]

broadcastsearch = 0

aggressive = 0

serversearchinterval = 30

serveraddr = 192.168.x.x
```

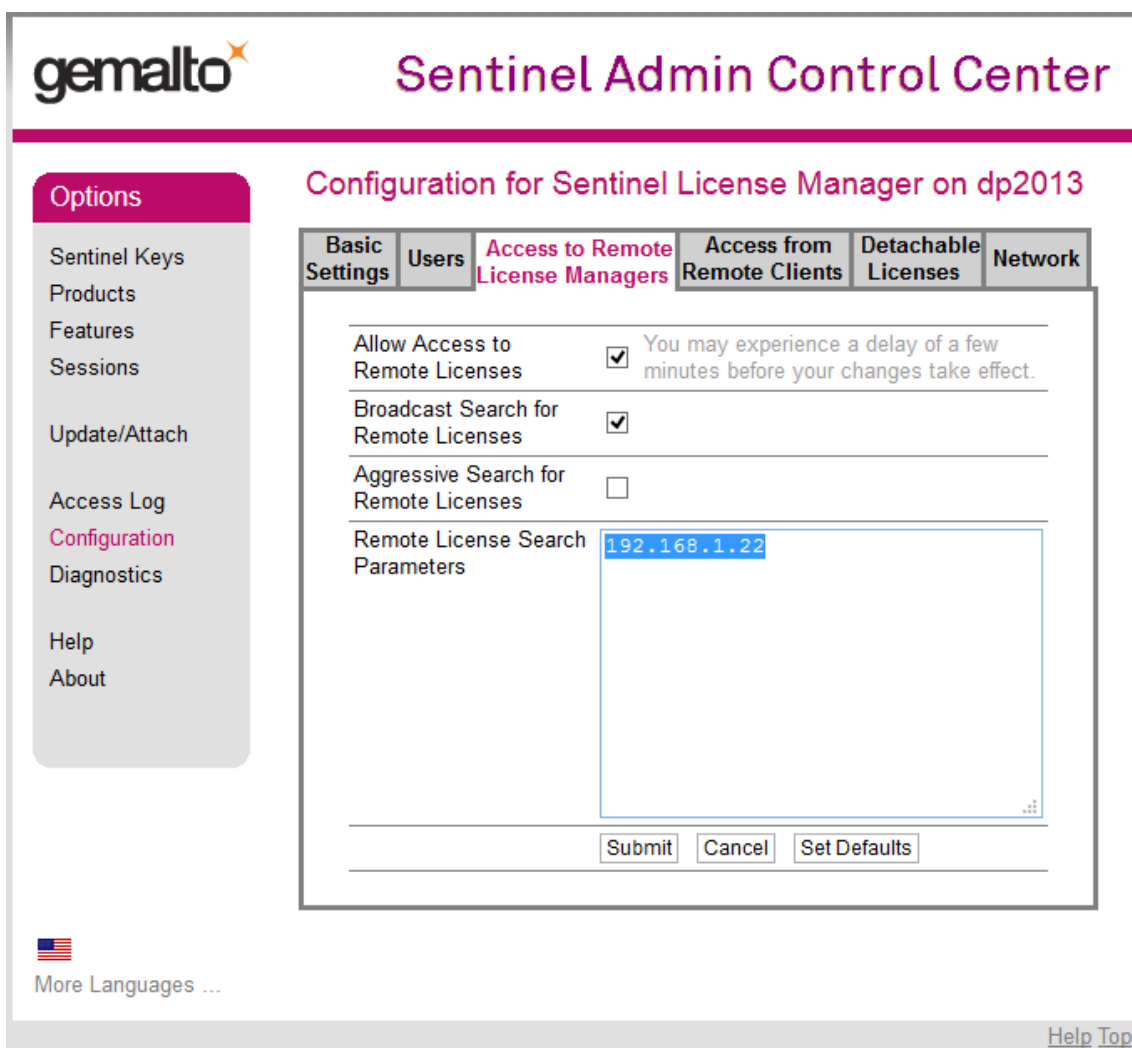

Fig. 2-11 Sample license server address setting in Sentinel Admin Control Center

It is also possible to define the settings only for one software ("batch code" or "vendor ID" in Safenet-Sentinel terminology) by creating a file named *hasp_vendorID.ini*. For ATENA, the filename is **hasp_50699.ini**. The file is to be placed in `%userprofile%\AppData\Local\SafeNet Sentinel\Sentinel LDK\`

hasp_50699.ini, (e.g., C:\Users\u1\AppData\Local\SafeNet Sentinel\Sentinel LDK\hasp_50699.ini for Windows Vista, 7, 8 or C:\Documents and Settings\u1\Local Settings\Application Data\SafeNet Sentinel\Sentinel LDK\hasp_50699.ini for Windows XP. The above files define the settings only for one user ("u1"), but it is also possible to set the network key search for all users by placing the file in

%ProgramData%\SafeNet Sentinel\Sentinel LDK\ hasp_50699.ini.

Solution 1/ATENA 4.3.1 and older: download the sample NetHASP configuration file **nethasp.ini** (see Download section on <http://www.cervenka.cz/>, or create a new file by pasting the contents below), copy it to the ATENA installation directory, and edit it to set the NH_SERVER_ADDR to the IP address of your Licence Manager server. **ATENA** should now always find the correct network key first and start normally.

Sample NetHASP configuration file nethasp.ini:

```
[NH_TCPIP]

NH_SERVER_ADDR = 192.168.x.x

;NH_SERVER_ADDR = <Addr1>, <Addr2>           ; IP addresses of all the NetHASP
search.                                       ; License Managers you want to

; Unlimited addresses and multiple
; lines are possible.
;
; Possible address format examples:
; IP address:      192.114.176.65
; Local Hostname: ftp.aladdin.co.il

NH_USE_BROADCAST = Disabled

;NH_USE_BROADCAST = Enabled or Disabled; Use TCPI/IP Broadcast mechanism.
```

Reason 2: blocked or slow network communication with the **License Manager**

Solution 2: please try if temporarily disabling the firewall solves the problem or not. If so, configure the firewall on both the workstation and the server to allow the communication between **ATENA** and the **License Manager** on ports 475 and 1947, both TCP and UDP. On the computer with the network key attached, these ports need to be open for both incoming and outgoing communication for the **hasplms.exe** executable file (typically installed in C:\WINDOWS\system32\hasplms.exe; for older HASP drivers, the driver executable is **nhsrv.exe**). On the workstation running **ATENA**, the ports need to be open for all ATENA executables for outgoing communication.

Note the Application Rules in your firewall may need to be re-defined after installing a new **ATENA** version.

Moreover, please check if the computer where the network key is connected and the **License Manager** running (NetHASP server) is not overloaded with some analysis (or other CPU load) or with a lot of network traffic (high load can lead to slow/late responses and, as a consequence, some timeout limits). You can also try to adjust (extend) the Timeouts in **nethasp.ini** (**ATENA 4.3.1** and older) or the corresponding settings in **hasplm.ini/ hasp_50699.ini** (**ATENA 5.0.2** and later – see Reason 1 above):

```
Set NH_SESSION = <seconds>
```

in the [NH_COMMON] section, where <seconds> is the desired initial search period (default: 2 sec) and

NH_SEND_RCV = <seconds>

(default: 1 sec).

2.4.14 Problems upgrading a HASP Key

2.4.14.1 HASPPROG (ATENA v4 license extensions)

If you are experiencing problems with the utility for upgrading an ATENA hardlock after a license extension, download and install the older HASP driver from <http://www.cervenka.cz/downloads/older-hasp-driver-command-line-installation-v.-4.995.22>. Typical messages reported by the **HASPPROG** utility are "Hardlock not found", "Error -100", or "Error -2"). Please understand this driver only supports 32bit operating systems.

1. Unplug the hardlock from the computer.
2. Unzip the archive into some directory and run the **Hinstall.exe** program. In that directory type the following command

```
hinstall -r -kp -alldr
```

this should fully uninstall any drivers.

3. Now install the driver using the same program in the same directory by typing the following command:

```
hinstall -i
```

4. Now attach the hardlock to the computer. Run the HASP upgrading utility (haspprogXXX_Y).
5. Try to run **ATENA**. If there are problems finding the key, please re-install the latest HASP drivers (<http://www.cervenka.cz/downloads/hasp-driver-command-line-installation-v.-5.86> or newer)

2.4.14.2RUS (upgrade to ATENA v5)

When upgrading from **ATENA** v4 to v5, you also need to update your hardware key to be able to use the new version. We recommend doing so before starting the installer. Please download the HASP Remote Upgrade utility (**RUS**)

http://www.cervenka.cz/downloads/ATENA500/RUS_MDTKB.exe

and follow the Remote Update Instructions for HASP Hardware Key [20].

Basically, you extract + send us info about your HW key and we send you a file to upgrade your key for the new version. Please understand that old keys (HASP4 USB or Parallel) can not be upgraded and have to be exchanged - let us know if this is your case.

Install the latest drivers

If collecting the key information in RUS ends with an error, first please make sure you are using the current HASP driver (6.56 as of May 2013). You can download it from the HASP/Safenet-inc web:

<http://www.safenet-inc.com/minisites/SRM/Downloads.aspx?s=&c=End+User&p=all&o=Windows&t=Runtime+%26+Device+Driver&l=all>

Sentinel HASP/LDK Windows GUI Run-time Installer Sentinel HASP, HASP HL, HASP4, Hardlock, Sentinel LDK Windows 13.2 MB 6.56 2013-03-20

Install the drivers, then start the RUS.

Only connect the ATENA key

Second, if you have other keys (for different programs) connected, please disconnect them before starting the RUS (only keep the ATENA key connected).

Key firmware update

Third, some older HL keys may need a firmware update (from version 2.16 to 3.25) to be applied prior to the license update. Download the update utility from the HASP/Safenet-inc web:

<http://www.safenet-inc.com/sentineldownloads/?s=firmware&c=all&p=all&o=all&t=all&l=all>

HASP HL Firmware Update Utility (EXE file) Sentinel HASP Win32 Win64
1.23 MB 2.16 to 3.25 2010-01-01

Unpack the archive, connect the key and run the **FirmwareUpdate.exe** utility, then click **Apply Update**. See Remote Update Instructions for HASP Hardware Key [20] for detailed instructions.

2.4.15 I get the warning: "Zero RHS vector", what is wrong?

This message means the right hand side of the equation system is null, which is a consequence of having no external loading – please check if your boundary conditions applied as intended.

3 ATENA ENGINEERING

This section contains problems and solutions specific to the ATENA Engineering graphical user interfaces. Currently there are two user interfaces available for **ATENA Engineering: ATENA Egr 2D** [2] and **ATENA Egr 3D** [3]. These programs can be used for static analysis of 2D and 2D problems respectively.

3.1 ATENA Engineering (general)

This section contains problems and solutions that are common to the both 2D and 3D GUEs.

3.1.1 How to apply cyclic load?

Please, always remember loads are incremental in **ATENA** (see also 2.2.15). Let's assume the supports are defined in Load case 1, and the two directions of the load are defined in LC's 2 and 3 (to always apply compression, the loads are defined separately for the two direction, e.g., negative Z displacement to the top plate in LC 2 and positive Z displ. to the bottom plate in LC 3).

Then, the load steps for 1 cycle can look like this:

1. loading n steps with LC's 1 and 2, positive multiplier
2. unloading n steps with LC's 1 and 2, negative multiplier
3. loading to the other side m steps with LC's 1 and 3, positive multiplier
4. unloading m steps with LC's 1 and 3, negative multiplier

Anyway, do not forget to define monitoring points for all quantities of interest, at least the displacements and reactions both loading points (see also 2.1.13). For more information about cyclic and fatigue loading, please see 2.2.26.

3.1.2 Display problems with "Desktop Composition" in Windows Vista/ 7

In Windows Vista and 7, "**Desktop Composition**" has to be disabled if you notice display problems. Right click on the **ATENA 3D** and **2D** items in the start menu, select Properties, then the "**Compatibility**" tab. Check the box "**Disable desktop composition**" (in **ATENA 4.2.7 – 5.0.2**, this is handled automatically by the installer; **ATENA 5.0.3** and later should work with Desktop Composition enabled).

In some cases, changing the display theme (**Control Panel | Appearance and Personalization | Personalization | Theme**) to "**Windows Classic**" can also help with display problems.

In Windows 8 and 8.1, it is not possible to disable Desktop Composition for a program any more – please update to **ATENA 5.3.5** or later to work with these OS versions.

In **ATENA 5.4.1c** and later, you have a choice of rendering methods to avoid display problems (at cost of speed), see **ATENA 3D User's [3], 3.2.6.1 Options – Settings**.

3.1.3 The analysis stops with the message "Error when saving results External exception E06D7363"

This message typically means exceeding the free disk capacity, or the maximum file size (about 2GB). After making sure there is enough space on your disk(s) (both the one with the model directory, and the one with the system temporary directory), we recommend to reduce the model file size by only saving the results for selected load steps (instead of for all steps), e.g., only each 5th or 10th step, or, in case of cyclic loading, for the max., min., and zero load points of each load cycle.

See also section 2.2.17 The analysis runs too long for general tips on reducing the size of your model.

3.1.4 Garbled text in some dialogs

If some of the texts are displayed wrongly, e.g., some national characters appear on your computer instead of "-]" in the sign for dimensionless values "[-]" or "Definition arc by 3 points" or at other places, you can solve the issue by setting the codepage for non-unicode programs to english/western europe/Latin 1/CP1252 (please ask your system administrator for help if needed).

3.2 ATENA Engineering 2D

Problems and messages specific to the Engineering 2D graphical user interface (GUE [2]) are presented in this section.

3.2.1 Error messages during analysis: Canvas does not allow drawing, Invalid pointer operation, or Control 'PN_Middle' has no parent window

Sometimes, messages like "Canvas does not allow drawing", "Invalid pointer operation", or "Control 'PN_Middle' has no parent window" appear during the analysis. If this happens and the analysis stops, please re-start the calculation from the latest stored step. If you do not zoom, pan, or change the results display while the analysis is running, the probability of problems is significantly lower. Not displaying any results also helps to reduce the risk.

3.2.2 Only X stresses/strains displayed during analysis

In 2D runtime, the display selection box sometimes lists stresses and strains in X direction only. If you encounter this problem, change the materials' order such that the first one is not a reinforcement material.

3.3 ATENA Engineering 3D

This section is devoted to issues specific for the Engineering 3D graphical user environment [3].

3.3.1 Problem restoring minimized ATENA 3D window

ATENA 3D v4 sometimes can not be restored by clicking when minimized into the Windows taskbar. If this occurs, please open the **Task Manager** (Shift+Ctrl+Esc) and restore the window using the "**Switch to**" command in the context menu brought by right-clicking **ATENA 3D** in the applications list (Windows 7 and older) or expand the **ATENA 3D** (32-bit) item in the **Apps** list at the **Process** tab and double-click the "[modelname.cc3] **ATENA 3D**" line (Windows 8).

3.3.2 Problem creating an opening (More than two surfaces are connected to the edge n.XX!)

When creating an opening in a macroelement in **ATENA 3D** program, the process is the following:

1. Create the macroelement without the opening.
2. Define the joints for the opening. Typically they will lie in one of the surfaces of the original macroelement.
3. Connect the opening joints to form lines.
4. Define an opening.
5. Extrude the opening by a certain length such that it exactly ends on the opposite macroelement surface.
6. After the extrusion manually delete the surface that remains at the bottom of the opening. The easiest way to do so typically is the following:
 - 6.1. remove the surface at the hole bottom (created during the extrusion, coinciding with the opposite macroelement surface)
 - 6.2. create an opening in the macroelement surface, using the lines remaining in the plane after the extrusion (which previously formed the superfluous surface deleted in step 6.1).
7. Now the opening should be ready.

Model precision

If you have problems with nonplanar surfaces or similar while modelling small geometry entities, please see also 3.3.8.

3.3.3 Problem meshing geometry created in older ATENA versions

In the case of geometry created in older **ATENA** versions, sometimes the mesh is not generated for a macroelement and an error is reported. In this case it is necessary to open the problematic macroelement for editing and close it again by clicking **OK** (i.e., recreating it is not required, unlike in 3.4.3).

**3.3.4 I have a bug; when I click on the button Generate in order to generate the mesh, I get the following error:
CCFEModelGenerateExc: T3D generator error code: 10
Source line: 157, file: ..\..\Sources\T3d\atena_cpp.cpp, last modified at: Fri Nov 19 13:5139 2010**

Typically, this error occurs when there are wrong meshing settings, e.g., mesh compatibility set for a contact between macroelements with incompatible meshing parameters, or for geometry which can not be meshed with the mesh settings - like a ME with many joints just 0.1mm apart to be meshed with 10cm elements. You can find a reference of the mesh generator error codes and other details in the T3D Manual [17].

You may also need to adjust the model precision, see also 3.3.8.

If you can not find the problem source, please send us the model (.cc3 file ZIPped) and your ATENA User ID (WR) as instructed in 2.1.1.

It is the best choice to build a lot of simple macroelements (preferably objects with 6 faces) instead of one only (big and complicated), so that you can easily find the wrong one and rebuild it.

3.3.5 When I try to run the analysis, I get the "Illegal element type specified for the shell/plate macroelement x (quadratic brick)". This error is given for all the shell elements I used.

Please set the shell macroelements to be meshed using quadratic brick elements:

1. Make sure the macroelement geometry has six sides with four edges each (replace complicated MEs with several simple ones)
2. In **Mesh | Generation**, set the **Elements** to **quadratic**
3. In **Mesh | Macroelements**, set the **Mesh type** to **Brick**

See also section "3.7.2.2.7 Shell Macroelements" of the ATENA 3D User's Manual [3].

3.3.6 When starting the analysis, the message "CCFEModelExc: Can not create contact elements on Contact (contact XXX)! Refine mesh in the neighbouring macroelements" appears

This message means there is not even a single complete element surface in the Slave surface of the contact and therefore, the connection can not work. To solve the issue,

1. Make sure the side with smaller finite elements is the Slave (see also ATENA 3D User's Manual [3], section 3.7.2.3 Contacts).
2. Consider if you can set the contact to **No Connection**, i.e., if it is just a random overlap or an unimportant border of a larger (correctly connected) contact (see also 2.2.14).
3. If the small contact is important, refine the mesh at the Slave side to have at least one whole element surface in it.
4. If the refinement results in a too fine mesh (too many elements), consider changing the geometry in a way to prevent the small or narrow contacts.

3.3.7 How can I apply triangular or trapezoidal load in ATENA 3D?

In **ATENA Engineering 3D**, triangular and trapezoidal loads are not supported by the GUE (unlike **ATENA Engineering 2D**, where one can define quadrilateral loads on lines, see the listbox **Type** in the **Line load** dialog, or **ATENA Science**, where one can define linear gradients for most load types by specifying the coefficients in the ATENA-GiD interface, although this is not as comfortable as specifying point values).

Probably the easiest way to apply such a load is to create an elastic trapezoidal macroelement with a low elastic modulus (typically, 1/20-1/100 of the E of concrete) and zero Poisson's ratio, and apply a body force corresponding to the desired trapezoidal load.

3.3.8 Problems with nonplanar surfaces, joints not inside macroelements, etc.

If **ATENA 3D** complains about nonplanar surfaces or joints not located inside macroelement or similar, you may need to increase the number of decimal digits from the default of 4 to 5. Please note the "Decimal digits" setting in **General | Analysis information | Global** can only be increased, i.e., changed from 4 to 5 but not from 5 to 4 - make sure to have a backup copy of your model before changing the value.

Please keep in mind that increasing this value also has influence on the automatic detection of contacts between macroelements, planarity checks, and other things. Setting a too high value may lead to severe problems with mesh generation, contacts, and analysis in general.

3.4 Older ATENA Engineering issues

This section could be called an archive of general problems believed to be solved in the current ATENA Engineering version.

3.4.1 When I start ATENA 2D or 3D in Windows 8.1, I get error messages complaining about "COUNTRYSIGNTOINT – invalid COUNDRYSIGN value"

The Locale handling has changed between Windows 8 and 8.1. Please update to ATENA 5.0.3 or later.

3.4.2 Problem/Fix for ATENA v3.3.0 installation

Symptoms: after **ATENA 3.3.0** is installed, **ATENA 2D** crashes at startup with an initialisation error in FAVystup.dll or "catastrophic failure".

Reason: some DLLs were not properly registered

Solution: make sure you have administrator rights. Unpack rega2d.zip (e.g. into c:\temp) and run rega2d.bat. Try to run **ATENA 2D**, it should start normally now.

3.4.3 Mesh generation errors for some macroelements

In **ATENA 3D** 4.3.0, a problem causing mesh generation errors with some models has been fixed. To fix older models, open the problematic macroelement for editing, move a joint, save the modified macroelement, open it again and move the joint back. Then, the mesh should generate normally (see also 3.3.3).

3.4.4 Problems with models involving springs

In **ATENA 3D** 4.3.0, a bug when copying springs has been fixed. We are sorry it is sometimes not possible to repair damaged models from older versions.

For recommendations on defining nonlinear springs, please see 2.2.16.

3.4.5 Problem with automatic creation/deletion of interfaces

In **ATENA** 3.3.1 and older, interfaces were sometimes deleted or not created when a macroelement was added/copied or deleted in **ATENA 3D**, or not deleted when a macroelement was moved.

This is fixed in version 3.3.2, please upgrade. Users of version 3.3.0 and newer with a valid maintenance agreement can download the upgrade online in the Downloads section.

With old data, application of the corrected contact checking algorithm has to be triggered by adding and deleting a macroelement.

If your model has been created in version 3.3.2 or later, please see 3.3.8.

3.4.6 Dead weight was not correctly applied in analysis in ATENA 3D

4.1.x

Body load (dead weight) was not correctly taken into account in **ATENA 3D** 4.1.x prior to 4.1.3g. The problem did NOT occur in **ATENA-GiD**, **AtenaWin**, or **ATENA 2D**. A patch is available for download <http://www.cervenka.cz/downloads/aten4-4.1.3g-patch>. The problem is also solved in **ATENA** 4.1.4.

3.5 SARA

Issues related to our stochastic package **SARA** (Structural Analysis and Reliability Assessment) are handled in this section.

3.5.1 SARA Studio 3D can not start ATENA analysis

SARA Studio 3D can not start **ATENA** analysis in version 3.3.2. The analysis of the generated samples (.cc3) can be run manually. Or, upgrade to **ATENA** 4.1.1 or later.

3.5.2 SARA Studio does not work with ATENA 5.0.0 pre-release

Please reinstall **ATENA** 4.3.1g with **SARA** or wait for the final release.

4 ATENA SCIENCE

This section includes problems and solutions specific to **ATENA Science**, a graphical environment for solving problems in Statics, Creep, Thermal and Dynamics.

4.1.1 Numerical problems with temperature dependent material properties (Fire or other thermal load)

Here are some general remarks with respect to Concrete Temperature Dependent material properties

- It is better to define the temperature dependency functions such that no parameter drops totally to zero. We generally recommend not letting the parameters drop below 1% of the original value (i.e. 0.01)
- It is mainly important to have a temperature dependence of f_c , f_t and E , ϵ_{cp} , and of course ϵ_t , but the others can be left constant.
- It is important to use the total formulation with about 20 steps
- It is also recommended to use the initial stiffness approach, i.e. elastic stiffness and calculation each step.

See also the sections 2.4.2, 2.4.5 on general numerical problems.

4.2 ATENA-GiD

Problems related to the ATENA-GiD interface and using **GiD** as Pre- and Postprocessor in general.

4.2.1 Some GiD models and examples need to be transformed - Error in line 2 at C:\xxx\yyy.gid\yyy.uni system ATENA_SI_MN_AND_M is not defined

Older GiD models, including some examples distributed with **ATENA**, need to be transformed to the new version of the **ATENA-GiD** scripts. If you get an

Error in line 2 at xxxxxxxxx.uni: system ATENA is not defined

when opening a project, click **OK** and go to **Data | Problem Type | Atena** (or **Data | Problem Type | ATENA v4** when working with **ATENA** version 4) and select the corresponding type, i.e., **Static** or **Creep** or **Transport** or **Dynamic**. Then choose **Transform to new problemtype** (**Transform**, NOT **Update** - the latter would destroy boundary conditions, material assignments, etc.). After that, the project should work normally.

Background: This error occurs if the ATENA-related problemtype is not correctly recognized by **GiD**. The most frequent situation is when you open an older model, e.g., created in **ATENA-GiD** 4.3.1, in **ATENA-GiD** version 5, because the names of the ATENA-related problemtypes have changed from ATENA v4 Static (or Creep/Transport/Dynamic) to ATENA Static (Creep/Transport/Dynamic) between versions 4 and 5.

If you have both 4.3.1 and 5.0.0 scripts installed in your **GiD**, the old models open in 4.3.1, without the error message, however, you have to manually transform anyway to continue your work with the model in **ATENA** version 5. In other words, if you only use v5, the only difference is to click one more message the first time you open an old model, which is probably not worth re-installing or copying the v4 scripts into your **GiD** (see section 4 ATENA-GiD INSTALLATION of the ATENA-GiD User's Manual [16] for instructions how to install the scripts).

4.2.2 During model transformation, the unit system is changed to the default (m, ATENA_SI_MN_AND_M)

Sometimes, the unit system is changed to the default (m, ATENA_SI_MN_AND_M) during model transformation (especially if the differences between the old and new ATENA-GiD versions are larger). To correct this, please switch to another unit system, then to the intended system.

4.2.3 My working screen is black and I can not change it. Other display problems in GiD

If you have problems with your graphics card, start **GiD** in Software OpenGL / Safe Mode. We always recommend video boards designed for CAD, e.g., nVidia FX series or ATI FireGL/FirePro series (see also 2.1.6 I plan to buy a new PC to run ATENA on it, what do you recommend?). You should also use the latest GiD version (currently, 11.0). If you are using an older **GiD** version (8.x.x or 9.x.x) under Windows Vista or 7, it is also recommended to disable Desktop Composition for **GiD**, see section 3.1.1.

4.2.4 Problems with GiD license, USB or network floating

Please follow Chapter 3 GiD Installation and Registration in ATENA-GiD User's Manual [16] to register your GiD license.

It is important to understand the GiD license number is not identical to the GiD Password. The Password to be entered into the GiD registration dialog is obtained through the GiD web based on the license number and the *Sysinfo* corresponding to the USB flash disk.

If you are using a network floating license for **GiD**, install **PasServer** on the computer that will work as license server. Follow the instructions from the GiD web <http://gid.cimne.upc.es/gid-plus/tools/passerver> to get the vendor key based on the *Sysinfo* corresponding to the server and your network license number and enter it in the **PasServer**. When starting **GiD** on your workstation, enter the IP address of the **PasServer** in the password box. Make sure no firewall is blocking the communication between **GiD** and the **PasServer** (similar to NetHASP Solution 2 in Section 2.4.12).

4.2.5 GiD claims: You don't have assigned Material 0 at Element xxxx For first number of unassigned element see *.dat file

The message appears while the ATENA Input File (.inp) is being written. It informs you which element (xxxx) has no material assigned. Use the **Signal** command to check where it is located. Use the **List** command to see its properties (layer, higher entity, ...).

Typical reason for this message (apart from the obvious one of forgetting to assign material to a volume or reinforcement) is that **GiD** automatically creates mesh for surfaces not being part of any volume and lines not being part of any surface. Which means that if you accidentally create duplicate lines or surfaces or forget to delete some auxiliary ones, mesh is generated for them.

If you wish to keep them, you can either manually assign mesh criteria **No mesh** to them, or freeze the layer where they are placed (after deleting the old mesh).

If you do not need these entities, you can just delete them. Note **GiD** rejects to delete any entity being part of a higher entity, which allows the following “trick” to quickly delete the entities responsible for the unwanted mesh elements: For example, if the element reported without material is a Line element, you can turn off all layers with reinforcement bars, run the command **Geometry – Delete – Lines**, and select everything through window. After pressing **Esc**, only the lines not belonging to any surfaces get deleted and you can read in the GiD response how many lines were rejected and how many deleted. Surfaces not belonging to any volume can be deleted the same way, i.e., through **Geometry – Delete – Surfaces** and selecting everything.

4.2.6 Message in line number 63. error: Materials "CCShellMaterial" and "CCBeam3DMaterial" are permitted only for Element Hexahedron

Please read section "5.3.2 Shell Material" of the ATENA-GiD User's Manual [16]. The layered shells and threaded beams in ATENA are modelled with quadratic brick (hexahedra) elements, not 2-dimensional quadrilateral elements or 1-dimensional bar elements.

4.2.7 I have an error when I try to edit the material properties in GiD: Error: can't set ::ttkcb_int__gid_material3_level_combo": can't read "GidData(MAT,,numprop)": no such element in array

If you get errors while opening the **Material** dialog or selecting a material in it, e.g.,

can't read "GidData(MAT,,numprop)": no such element in array

while executing

```
"setNumProp $GidData($StructName,numprop)"
```

(procedure "BuildStringValue" line 15)

invoked from within

(...)

the reason are usually special characters in a material name, or material names starting with a number.

We recommend using names starting with some letter, and use only letters, numbers and _ (underscore), although some more characters may also work fine. To prevent such problems, do not use parenthesis [], spaces, quotation marks “ ”, comma ,, semicolon ;, national or other special characters in material or other names in **GiD**.

Sometimes, it is possible to save the model:

Make a backup copy of your model (e.g., a .ZIP archive), then open the .mat file in a text editor (**NotePad**, **PSPad**, or similar, not Word) and look for the reinforcement material definitions. Replace the broken names with some 100% unproblematic (letters, numbers, underscores).

Check if you can open the model, and if the material definitions are OK (check all materials used, as broken quotation or parenthesis or similar may result in damaging the material(s) below the broken material definition).

If that does not work, unzip the backup, and simply replace the .mat file with the file from another GiD model, or from the template in the GiD Problemtypes directory, and define and assign your materials again.

4.2.8 I can't display the results on Contacts in AtenaWin or ATENA Studio

If you can not see the results on contacts, please try one of the following workarounds:

A. Switch the display to **Wireframe model**.

B. Define an **Activity** with only the Interface elements, switch the display to **Solid** or **Wireframe**. Then, you can enable the **Full model Outline** to see the position of the contacts in your whole structure.

Please note the contacts in compression (overlapping) are not displayed if you display the deformed structure.

C. Import the results into **ATENA 3D** (see also 4.3.1.1 for more information about reading calculated results into the ATENA Engineering 3D Postprocessor) and display the results there.

4.2.9 During analysis start/.inp file creation, I get errors like: ',8m' Expected identifier at position 1

You have used a decimal comma “,” instead of decimal point “.” somewhere. Please remember you have to always use decimal point everywhere in **GiD**, regardless of your OS locale settings. See 4.2.7 for instructions how to possibly recover your model by manually correcting the .mat or .prb file.

4.2.10 During analysis start/.inp file creation, I get errors like: Error: Non-signed(nondeefined) element type! and Info: Unknown element type was written to inp file. Find "Unknown element type" in inp file.

First of all, please check if you have not accidentally selected the option **Quadratic9** in **Mesh – Quadratic type**, and correct if needed, then re-generate the mesh to reflect the change. So far, **ATENA** only supports the **Normal** and **Quadratic** mesh types, not the **Quadratic9**.

If the problem is not solved by the above, look into the Input file (.inp) and search for “**Unknown element type**”. You should find something similar to the example below, from which you can identify additional information about the problematic elements and the material for which they are generated.

// Element group definition

```
Error: Non-signed(nondeined) element type! IsQuadratic=2; ElmsType=5;
ElmsNnode=27; AddTranspAnalysis=0; GeomNonlinearity=NONLINEAR;
CCShellMaterial=0; CCBeam3DMaterial=0; oCC2DInterface=0; CC3DInterface=0;
CCModelBaXi94=0; CCRinforcement=0
```

```
ELEMENT GROUP ID 335 TYPE 335 /* Test/No - 35 */ MATERIAL 3
GEOMETRY 3
```

ELEMENT INCIDENCES

// Test No CurrentType=35 ElmsType=5 ElmsNnode=27

// Unknown element type - vsechny ostatni pripady

ElmsNum =	1	ElmsConec =	52246	51673	51668	52243	52697	
52227	52224	52694	51964	51669	51960	52244	52475	51963
51959	52473	52469	52225	52467	52695	51962	52221	51961
52219	52474	52468	52220					

4.2.11 GiD gives the following warning while meshing: Condition 'Reinforcement_Elems_Identification' has flag 'on body elements' and maybe it needs flag 'on face elements' in the .cnd file in the problem type

The conditions used to recognize lines representing reinforcement **Reinforcement_Elems_Identification** and **Reinforcement_Nodes_Identification** are assigned automatically to all lines not belonging to surfaces at the moment of mesh generation. If you accidentally try to generate the mesh when some surfaces are not yet built completely, it also gets assigned to any “free” lines and remains there when these lines become parts of some surfaces and volumes. Then, you get this warning:

Condition 'Reinforcement_Elems_Identification' has flag 'on body elements' and maybe it needs flag 'on face elements' in the .cnd file in the problem type

(or maybe the entity must be forced to be meshed by the global variable ForceMeshEntities or with explicit Mesh criteria->Mesh)

Error when transferring condition 'Reinforcement_Elems_Identification' from geometry to mesh in line 5. It has not been transferred

The solution is to unassign these 2 conditions from all lines which do not represent reinforcement bars nor cables in all Intervals.

Note you can also manually assign these 2 conditions if an edge should also represent a reinforcement bar (for example in case of double plane symmetry).

4.2.12 A GiD dialog does not open when I click the corresponding icon or menu item

Typically, this is just because you have accidentally moved the dialog window behind some of the screen borders (or changed the display resolution such that the previously visible position is now outside of your monitor). In that case, pres **<Alt> - <Space>**, choose **Move** from the menu and use the arrow keys to bring the dialog back to your screen (actually, this is a Windows thing, not specific to GiD).

4.3 AtenaWin and AtenaConsole

This section addresses problems specific to the text-window runtime program **AtenaConsole** and the program **AtenaWin** [14] for runtime and post-processing.

4.3.1 I have an ATENA Input File (.inp), how can I start the analysis in AtenaWin or AtenaConsole or ATENA Studio?

Although not as comfortable as starting the analysis from **GiD**, in some situations it can make sense to start the analysis manually in **AtenaConsole** or **AtenaWin**, e.g., if you have modified the .inp file, prepared it on one computer and wish to start it on another one without **GiD**, or simply wish to save time compared to running in **ATENA Engineering 3D**.

One way is to start **AtenaWin** for the corresponding analysis type from the **Start** menu, open the .inp file, and press **Execute** command in the menu (or Shift-Ctrl-E). This is one of the ways. Another one, which is typically more effective and also suitable for **AtenaConsole**, is to start **AtenaWin** or **AtenaConsole** directly from the command line from the directory with the .inp file, i.e.,

1. open a command line window (e.g., "**Start | Run**", then type "**cmd**")
2. go to the directory with your input file (e.g., C: <enter> cd \scratch\ATENA\task\modelname\AtenaCalculation <Enter>)
3. start **AtenaConsole** or **AtenaWin**, e.g.,

3.a:

```
%AtenaConsole% /O /catch_fp_instructs modelname.inp modelname.out  
modelname.msg modelname.err
```

or 3.b:

```
%AtenaWin% /O /catch_fp_instructs /execute modelname.inp modelname.out  
modelname.msg modelname.err
```

To start the 64-bit version, use **%AtenaConsole64%** respectively **%AtenaWin64%** instead.

For dynamic analysis, add **/M CCStructuresDynamic** (or **/M CCStructuresCreep** for creep+shrinkage or **/M CCStructuresTransport** for thermal/moisture analysis) just before the **/O** (which says to overwrite the .out, .msg, .and .err files). If you start **AtenaWin** without the **/execute** switch, you need to start the analysis manually by pressing Ctrl-Shift-E or clicking the calculator icon.

See also Chapter "2 PROGRAM EXECUTION" of the ATENA Input File Format Manual [13].

To run an .inp in **ATENA Studio**, start the program (from the system menu, or through %AtenaStudio%/AtenaStudio64%), then click **Create new project from input file**, open the .inp, and select the corresponding analysis type (**Statics**, **Dynamics**, **Transport**, or **Creep**). Then, you can run the analysis as in any other ATENA Studio project.

4.3.1.1 Models from ATENA 3D analyzed in AtenaConsole

If you like to run a model created in **ATENA Engineering 3D** in **AtenaConsole**, first store the .inp file through **Data | Save INP files | Together**.

Saving results

Uncomment the "STORE TO" commands (i.e., remove the /* */ comment markers around the commands) corresponding to the steps for which the results should be saved, and run **AtenaConsole** with the modified .inp file.

Monitoring point definitions

The monitors defined in **ATENA 3D** are available in **AtenaWin** while the analysis is running, but with a few limitations:

1. you only see their internal names (not human readable)
2. they are defined "after iteration", not "after step"

However, both issues can easily be solved through simple edits of the .inp file - for 1., replace the string in the monitor definition with something legible, e.g., OUTPUT NAME "M_7FFD2680_E750_4160_A59B_5486642AD30A" with OUTPUT NAME "DisplXtop". For 2., replace MONITOR EACH ITERATION with MONITOR_2 EACH STEP in all monitor definitions.

Importing results into the ATENA Engineering 3D Postprocessor

To import the binary step result files into **ATENA 3D** for post-processing, use the **Files | Open other | Results by step** menu command. Of course, you can also post-process the results in **AtenaWin**.

4.3.1.2 Models from ATENA 2D analyzed in AtenaConsole

With a model prepared in **ATENA Engineering 2D**, there is normally no advantage in running your 2D analysis in **AtenaWin** or **AtenaConsole** – maybe the latter for maximum speed (and that is usually not a problem for 2D models). Moreover, to get the whole .inp from **ATENA 2D** is not as easy as from **ATENA 3D** - you would need to copy+paste each step one by one, or copy the first and then replicate it manually (see section 5.3.5 Input File Editing in [2]). An additional issue are monitoring points definitions, which are not included in the **Editing INP file** window. Therefore, it is generally not to be expected the extra work can be outweighed by the possible advantages of running the analysis in **AtenaConsole** or **AtenaWin**.

Post-processing the results

It is not possible to import the binary results files (calculated in **AtenaConsole** or **-Win**) into **ATENA 2D**, but if you do not like post-processing in **AtenaWin**, you can read

them into **ATENA 3D** (see *Importing results into the ATENA Engineering 3D Postprocessor* above).

4.4 ATENA Studio

This section is devoted to problems specific to the **ATENA Studio** [15] graphical environment for analysis runtime and post-processing.

4.4.1 After returning from Turbo mode or restoring a saved layout, not all windows are restored

Floating windows, like for example graphs not anchored in the main window, are not restored when returning from **Turbo** mode or restoring a saved layout. However, the diagram settings are not lost and the windows can be re-opened from the **View** menu.

4.4.2 Can not read results for postprocessing - CCEXception: An error during serialisation of the model CCStructures

If you get an error message when trying to create a project from calculated dynamic, creep, or transport results "CCEXception: An error during serialisation of the model CCStructures", and the model is not displayed, please select the corresponding **Project type** in the **New project from result files** dialog.

4.4.3 ATENA Studio does not start

If **ATENA Studio** can not start (typically, after a system crash "blue screen of death" or a power outage), it can be due to a damaged **user.config** file where the initial window position is stored. The file is stored under

%AppData%/Local/Cervenka_Consulting/Atena

There is a subdirectory, e.g.,

AtenaStudio.exe_Url_04qprm54dlif2vmvnoje5rwvmhjv3csd

or

AtenaStudio64.exe_Url_5c3y05wwa0h3culasjzml4iuvucu3tbw

for each group of ATENA versions, with subdirectories named by version numbers, e.g.,

5.7.0.16694

- just delete the **user.config** file you find there, and try again to start **ATENA Studio**.

If you cannot find the directory (starting with **AtenaStudio.exe_Url_** or **AtenaStudio64.exe_Url_**) containing the subdirectory named as your working ATENA version and you are working on the newest version, order the directories by date and the first (latest) directory should contain the directory named by your version number and in it, you should find the **user.config** to be deleted.

4.4.4 How can I check the local coordinate system of elements?

For Shells+Beams, LCS visualisation is possible using the **Output Attribute Element Orientation** (see also ATENA Studio User's Manual [15], 4.4 Output Data Attributes).

For all element types, including for example Interface Elements, there is another option allowing to show the orientation - go to the menu at the right side of **ATENA Studio**, choose the **Labels & Signals** toolbox and there under **Entity to show**, you can find, among other items, **Element LCSs**, which displays the Local Coordinate System of each element, including Interface Elements, in form of a 3-arrow cross, with the colours like the global coordinate cross = X red, Y green, and Z blue.

To see the colours clearly, it is recommended to disable the box **Light On** at the **General** tab of the **Properties** dialog of the **Structure** window. It also makes sense to define an **Activity** with just the Interface elements, and only show the rest of the structure as **Outline**.

REFERENCES

- [1] Cervenka, V., Jendele, L, Cervenka, J., (2016), *ATENA Program Documentation, Part 1, Theory*, Cervenka Consulting, 2016
- [2] Cervenka, V., and Cervenka, J., (2011), *ATENA Program Documentation, Part 2-1, User's Manual for ATENA 2D*, Cervenka Consulting, 2011
- [3] Cervenka, V., and Cervenka, J., (2017), *ATENA Program Documentation, Part 2-2, User's Manual for ATENA 3D*, Cervenka Consulting, 2017
- [4] Kabele, P., Cervenka, V., and Cervenka, J., (2010), *ATENA Program Documentation, Part 3-1, Example Manual for ATENA Engineering*, Cervenka Consulting, 2010
- [5] Cervenka, V., Cervenka, J., and Janda, Z., (2015), *ATENA Program Documentation, Part 3-2, Example Manual for ATENA Science*, Cervenka Consulting, 2015
- [6] Cervenka, J., (2001), *ATENA Program Documentation, Part 4-1, Tutorial for ATENA 2D*, Cervenka Consulting, 2001
- [7] Cervenka, J., Procházková, Z., (2016), *ATENA Program Documentation, Part 4-2, Tutorial for ATENA 3D*, Cervenka Consulting, 2016
- [8] Janda, Z. and Cervenka, J., (2009), *ATENA Program Documentation, Part 4-3, Tutorial for Construction Process in ATENA 2D*, Cervenka Consulting, 2009
- [9] Procházková, Z., Cervenka, J., Janda, Z., Pryl, D., (2016), *ATENA Program Documentation, Part 4-6, Tutorial for ATENA-GiD*, Cervenka Consulting, 2016
- [10] Sajdlová, T., (2016a), *ATENA Program Documentation, Part 4-7, ATENA Science – GiD FRC Tutorial*, Cervenka Consulting, 2016
- [11] Sajdlová, T., (2016b), *ATENA Program Documentation, Part 4-9, ATENA Science – GiD Strengthening of concrete structures*, Cervenka Consulting, 2016
- [12] Cervenka, V., and Niewald, J., (2005), *ATENA Program Documentation, Part 5, ATENA-FEMAP User's Guide*, Cervenka Consulting, 2005
- [13] Cervenka, J. and Jendele, L, (2017), *ATENA Program Documentation, Part 6, ATENA Input File Format*, Cervenka Consulting, 2017
- [14] Jendele, L., (2011), *ATENA Program Documentation, Part 7, AtenaWin Description*, Cervenka Consulting, 2011
- [15] Beneš, Š., Mikolášková, J., Altman, T. (2016), *ATENA Program Documentation, Part 12, User's Manual for ATENA Studio*, Cervenka Consulting, 2016
- [16] Cervenka, V., Cervenka, J., and Janda, Z., (2017), *ATENA Program Documentation, Part 8, User's Manual for ATENA-GiD Interface*, Cervenka Consulting, 2017
- [17] Ryppl, D., (2011), *ATENA Program Documentation, Part 9, T3D - Triangulation of 3D Domains - User Guide*, Czech Technical University in Prague and Cervenka Consulting, 2011
- [18] Pryl, D., (2014), *ATENA Program Documentation, Part 10, User Material DLL*, Cervenka Consulting, 2014

- [19] Cervenka Consulting Web (2013) <http://www.cervenka.cz/>
ATENA Troubleshooting <http://www.cervenka.cz/assets/files/atena-pdf/ATENA-Troubleshooting.pdf>
ATENA Known Issues <http://www.cervenka.cz/products/atena/known-problems>
Frequently Asked Questions <http://www.cervenka.cz/faq>
Forum <http://www.cervenka.cz/forum/index.php>
- [20] Stano, D., (2013), *ATENA Program Documentation, Part 13, Remote Update Instructions for HASP Hardware Key*, Cervenka Consulting, 2013
- [21] AmQuake Web (2014) <http://www.amquake.eu/>